



MASTER BROCHURE 2021

Setting new standards in kitchen
style and performance

MAKE IT WONDERFUL

FRANKE





More ways we're making it wonderful

Franke continues to innovate in key product areas

As a world leader in the design and manufacture of intelligent products and solutions for residential and professional audiences, we continue to lead the way in developing high-end design innovations.

Franke has built a reputation on producing high quality sinks and state-of-the art instant boiling water taps and we are extremely proud of what we produce.

Looking ahead we are delighted to be introducing some impressive new lines into our range.

We are committed to ensuring our customers experience the pleasures that cooking, eating and entertaining in a kitchen fitted with our products can bring. This is the very essence that inspires us to Make it Wonderful.



Make it wonderful with the Franke sink and tap range

It's easy to be ordinary; to have an ordinary home, filled with things you neither love nor hate. But you should never settle for ordinary and that's why we want to make everything we make wonderful. Wonderful turns a house into a home and turns work into play. Every Franke product aims to be wonderful in every way; from the first glimpse of carefully considered design, to manufacturing standards that ensure you can feel the quality and craftsmanship of every piece.

This brochure captures the spirit of wonderful in order to captivate and inspire you. A comprehensive range of sinks, taps and accessories can help turn an everyday kitchen into the extraordinary and turn a daily chore into a guilty pleasure.

Let everyone else be ordinary, while we make it wonderful.

Be inspired

We are constantly thinking of new ways to make our range even better, adding new products, new ideas and new innovations. Keep up to date with it all on our Facebook and Twitter pages.

 www.franke.ie

 facebook.com/FrankeHome

 twitter.com/FrankeUK

 youtube.com/UKFranke

 pinterest.com/FrankeUK

Contents

Introduction	6
Sink Range	20
Tap Range	70
Kitchen Solutions	102
Specifications	111



Over one hundred years of passion

Making something wonderful rarely happens overnight, and Franke has been pushing the boundaries for over 100 years. Founded in 1911, Franke was built on a foundation of precision engineering combined with traditional craftsmanship. Over 100 years later, those principles endure, while a focus on the changing needs and lifestyles of our customers has helped us become the world's largest manufacturer of kitchen sinks.

Swiss precision engineering

The Franke story began as a small sheet-metal business in Rorschach, Switzerland, established by Hermann Franke in 1911. Since then, we've established efficient and economic manufacturing facilities all around the world.

Many things have changed in the past century, but what is always the same is a set of values, characterised by respect, trust and openness. The values of innovation, entrepreneurship, quality and stylish design were in the heart of Hermann Franke and continue to be at the heart of the business, as we enter a second century of smart and stunning design.



Guaranteed for half a century of wonder



Once you've realised the kitchen of your dreams, it's only natural you want to retain it for as long as possible. To do that, you need reliable products of outstanding quality and Franke is guaranteed never to let you down. A huge 50 year guarantee on our sinks means that your Franke sink will be with you through those big moments in life and be part of your family for a generation or more.



We're confident, so you can be too

Few other manufacturers can offer such a promise to you and that's because we are dedicated to the highest standards of design and craftsmanship. Our guarantee protects your sink against manufacturing defects for half a century.

Great guarantees on our other products

You also have the peace of mind of a superb guarantee on our taps, which protects against defective materials and workmanship in the valve mechanism for 5 years and covers you for coatings and finishes for 1 year (5 years for stainless steel taps).

Our waste disposal units carry a 10 year guarantee - which is unmatched by any other brand.

Full details of our guarantees can be found on our website, but no matter which Franke product you choose, you can look forward to many years of trouble-free use. It's a product that stays in your family home so long, it's almost part of the family.

Visit www.franke.co.uk/guarantee

Complete your dream with ease

Find a sink to suit your style

To help you navigate the wide range of design, installation and functionality considerations surrounding your choice of sink, you'll have detailed information at your fingertips. Each option is explained fully over the following pages.



Add your perfect tap

Franke taps combine outstanding performance and stunning design to suit your taste – whatever it may be. Our taps are designed to fit a standard 35mm tap hole (except where indicated). It is also important to identify whether your home has a high or low pressure water system, as it will affect your choice of tap – your installer or kitchen retailer should be able to help with this.



Choose accessories and extras

We also have a number of stylish and innovative products that are specifically designed to enhance the aesthetics and functionality of your sink, streamlining kitchen tasks to preserve its look and longevity.



Discover full kitchen solutions

A working kitchen doesn't have to be a cluttered kitchen. Our range of clever storage and waste products helps to maintain a clean and clear space for those with even the busiest of lifestyles.

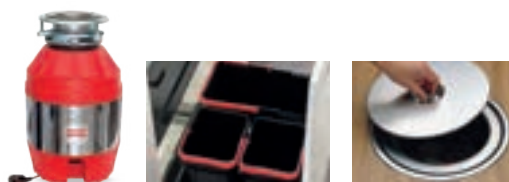

Innovation is in our DNA

INNOVATION 

We continue to be passionate innovators and our aim is to constantly improve the look and usability of our designs. Staying at the forefront of the industry is vitally important to us, so we have continually enhanced manufacturing techniques and made pioneering use of new materials to explore exciting new design possibilities. This means our range is always evolving to include the very highest levels of form and function.

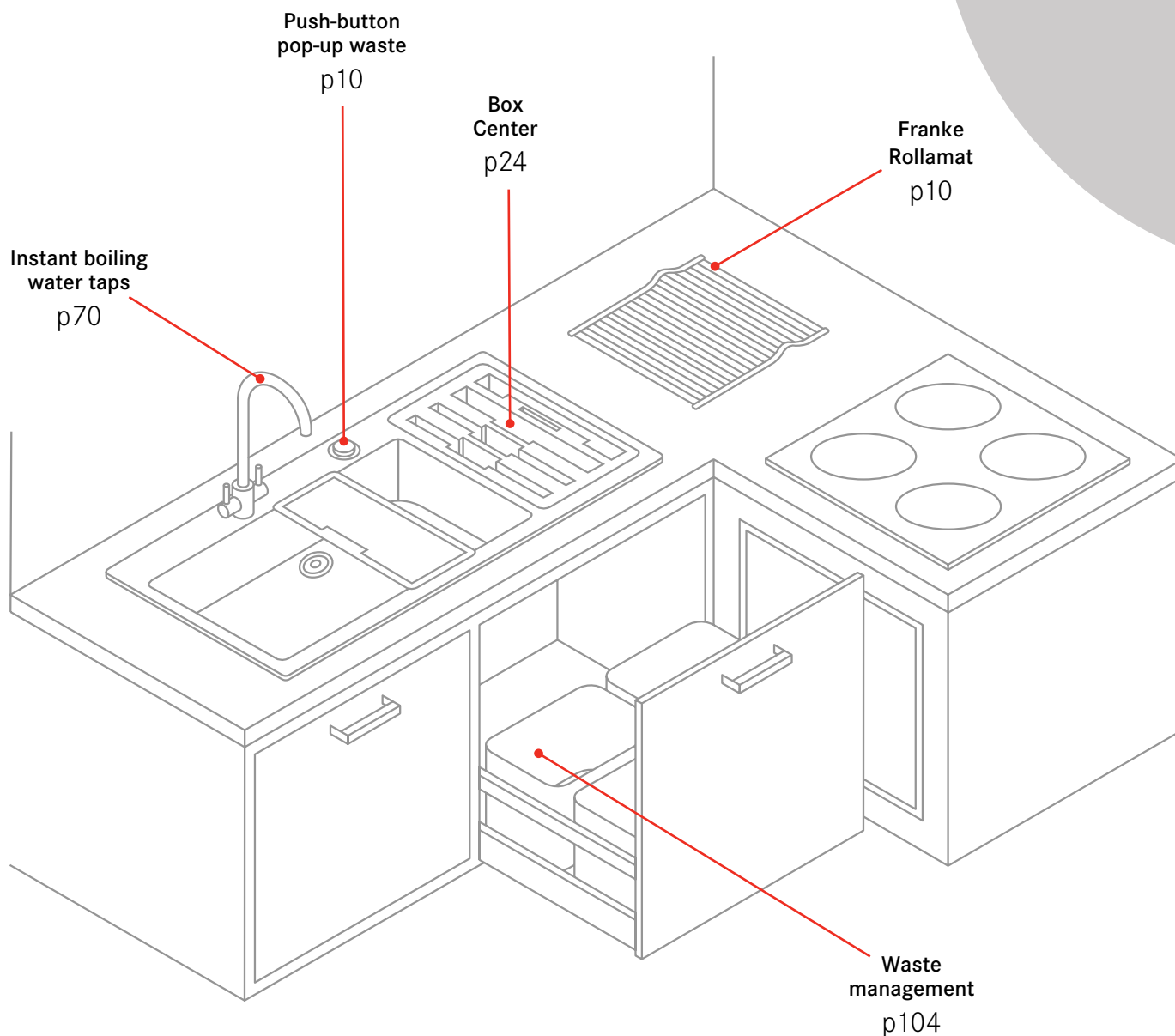

INNOVATION 



Franke Rollamat

The Franke Rollamat is a handy accessory, which can be used to drain glasses or crockery, but also doubles as a trivet to protect the work surface from hot and heavy cookware straight from the oven, hob or grill. When not in use, this innovative accessory can be rolled up and conveniently stored away.

The Rollamat can be used on any work surface and therefore with any undermount sink, but will specifically fit the drainer on certain inset sinks.



ROLLAMAT	COMPATIBLE SINKS	SIZE (mm)	FUN No.
Mythos	MYX	267x424	112.0591.081
Rollamat 30	BFG	298x410	112.0256.867
Rollamat 36	MRG,MRX	361x330	112.0075.642
Rollamat 40		400x400	112.0050.988
Rollamat 42		468x420	112.0030.882
Rollamat 44		468x440	112.0080.355
Fresno	FSG	220x400	112.0520.938

INNOVATION 



Push-button pop-up waste

A pop-up waste enables you to conveniently empty the bowl without putting your hands in the sink. The patented push-button system from Franke has been tested to not only give you an extremely robust feature, but it looks great.

INNOVATION 



Instant Boiling Water Taps

Get instant 100°C water at your fingertips, straight from your kitchen tap, with Franke Instant Boiling Water Taps. Perfect for making drinks or getting meals underway in a flash, they combine safety, stylish design and cutting-edge technology. The innovative electronically controlled Minerva 4-in-1 tap features a child safety function and filter warning light, while the Omni is the world's first mechanical 4-in-1 tap, providing filtered water alongside hot, cold and boiling water.



Hygienic Overflow

Many Franke sinks come with a Hygienic Overflow, which offers versatility for cleaning. Simple removal of the logo plate reveals the overflow aperture for easy, hygienic cleaning.



Slimfix®

The Slimfix® technology has enabled Franke designers to reduce the width, depth and profile of the outer rim, resulting in a sink virtually flush with the worktop and has a bowl and drainer which is deeper and more three-dimensional in appearance.



Box Center

Thanks to the new Box Center, the most important kitchen accessories become part of the sink unit and accessible all the time. These brand new large bowls are now available as inset/flushmount and undermount options and are a perfect combination, blending exceptional functionality with shining, minimalist design.



Andy Chef

Andy Chef is the ingenious solution for a well-organised and stylish kitchen, combining all the essential food preparation accessories you need on a daily basis. This compact, tailor-made holder includes a wooden chopping board, a professional chef knife and a strainer bowl and fits perfectly with our Box BXX range of sinks. Built to last in stainless steel and with a playful design, this sleek holder is the perfect addition to your family home. Thanks to its practical inner design, the accessories can also be safely stored and will dry entirely overnight.

Details that make a difference

At first glance, some features seem to be little more than decoration; others, you may not even notice at all. Sometimes, however, small details can make a huge difference. Whether it's to save you time, make cleaning easier, boost performance or simply provide an efficient solution for life's little challenges, every aspect of a Franke sink is carefully designed to make life easier.



Advanced waste systems

Franke sinks are equipped with stainless steel basket strainer wastes which can be used to prevent foodstuffs from entering the waste system. But the attention to detail does not stop there; underneath the sink, Franke waste kits may include such features as Sanitized® anti-bacterial properties and fast flowing air vent systems, whilst always ensuring they are as low-profile as possible, allowing you to benefit from extra cupboard space.



Deeper bowls

Many Franke stainless steel sink bowls are formed using a manufacturing technique known as deep-drawing and annealing. The bowls are formed using a 2-stage process which starts with deep drawing a flat sheet of steel. The annealing process allows the final bowls to be deeper, without compromising the integrity of the steel.



Heat and sound insulation

Selected Franke stainless steel bowls are sound insulated to reduce the sound of water in the bowl. This is achieved by rubber insulation pads under the sink, or by a sprayed dynaphon layer, applied during manufacture. The grey dynaphon spray also insulates, minimising heat escaping from the bowl, keeping water warmer for longer.



Sink accessories

It's the little things that make life extra special, so we've developed a range of extras to do just that. People use their sink in different ways, so these products correspond to common kitchen activities, complement the design of your Franke sink and turn it into the ultimate multi-purpose workstation.



To see the full range of accessories available for each sink visit franke.ie

Waste disposal units

Clever design frees the kitchen from unsightly and unhygienic organic household waste, leaving you to enjoy a clean and tidy kitchen. With an ease of use that's hard to beat, it can even take the most mundane of daily chores and turn it into a little guilty pleasure.

Thanks to a permanent magnet motor, Franke Turbo Elite Waste Disposal Units reach high speed in a split second, producing more torque per kilo than any other of its type. Whilst running water through the unit, food waste is instantly liquified into fine particles that are easily flushed through the pipework system.



Kitchen solutions

Everything in the kitchen should flow smoothly, not just the tap. That's why we create products to make your life easier in the kitchen and that help to maintain a tidy working environment.

The inset waste bin sits neatly in the countertop so food waste can be quickly and hygienically disposed of, while maintaining a minimalist look, and the Franke waste sorter range has multiple solutions to aid in the environmentally friendly disposal of waste.

Choose your perfect sink

As the kitchen sink is seen as the heart of the kitchen, it's the perfect starting point for creating your dream kitchen. Let your imagination run free with a range of fabulous options to help you maximise space and accentuate the look of the entire room. There are however certain functional considerations to take into account and the following information will help to ensure that your ideal sink is the perfect fit for your kitchen.

Inset sinks

Inset sinks are installed from above into a pre-prepared hole in your worktop. It gives you the widest range of sink shapes, sizes and styles to choose from.



Undermount sinks

Undermount sinks are installed underneath the worksurface and therefore require a solid surface worktop such as granite or wood. They are not compatible with laminate worksurfaces.



Belfast sinks

Belfast sinks can be used as either a freestanding feature with brackets or sit on top of base units.



Measuring your cabinet width

It is essential to correctly measure the cabinet width where your sink will be installed. The bowl (or bowls) will need to fit into this space. Each sink in this brochure will show a cabinet size, and your cabinet width needs to be equal to or greater than the stated measurement.

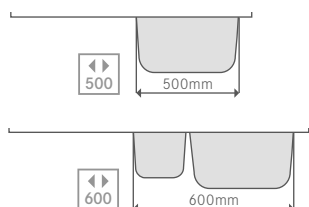

Bowl and drainer configuration

The type and position of your bowl depends on how you intend to use your sink. If you like room to clean large items like grill pans, a larger single bowl may be best for you, or for a multi-functional purpose, you may prefer the versatility of 2 separate working bowls.

The drainer location is also an important consideration. For many sinks you will need to choose the specific version you prefer – with the drainer on the left or right hand side. Conversely, other sinks are reversible which indicates the drainer can be positioned on either side.

Single Bowl

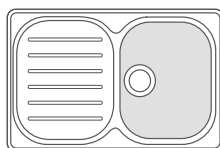

1½ Bowl

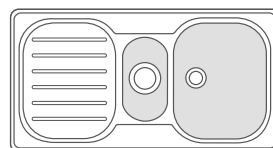

Double Bowl

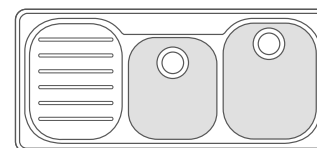

BOWL CONFIGURATION



LHD or RHD: This indicates whether the drainer on the sink is found to the left or to the right of the main bowl.



REV: These reversible designs have a tap hole at the front and back, giving you the freedom to position the sink to provide either a left or right handed drainer.



LHSB & RHSB: For sinks without a drainer but with more than one bowl, this indicates which side the small bowl is positioned.



Omni 4-in-1 Stainless Steel Instant Boiling Water tap

MORE
IN STORE

FRANKE

Franke More in Store

We believe that the best place to buy our products is in store. That's because you get a friendly face to listen to and offer expert advice. You also get an unrivalled opportunity to see and feel the quality of Franke for yourself.

That's why we created More in Store, an initiative to support our retailers in giving you great service and the best possible buying experience. What it means for you is more choice, better quality, more knowledge and unbeatable after sales support.

Find your nearest Franke retailer by using the Dealer Locator at www.franke.ie/dealers

Material and finish options

Everyone has a different vision of what would make their kitchen wonderful, and that often begins with how they intend to use it. The demands on your sink will dictate which material is right for your kitchen, as each precision-engineered material has individual character and unique benefits. Our range covers everything from the latest trends to traditional favourites, so all you have to do is pick the one that best fits with your cooking style, your lifestyle and your personal taste.



Image shows Kubus KNG 110 62 Onyx Sink.

Fragranite treated with Sanitized®

Fragranite is an exceptionally tough material which is highly resistant to burns, dents, chips and stains. It was pioneered by Franke and contains 80% granite to form a unique material with a subtle sheen that is warm to the touch.

Kitchens can be a critical location for spreading bacteria and demand special attention to hygiene. On unprotected material, bacteria can multiply every 20 minutes making surfaces unhygienic. The integrated Sanitized® hygiene function in Fragranite sinks helps to keep this area clean and provides the sink with lasting protection. It does not replace normal cleaning but helps to keep surfaces free from bacteria. Tests have proven that Fragranite treated with Sanitized® reduces bacteria and microbe growth by 99%.

Fragranite is available in a range of colours:

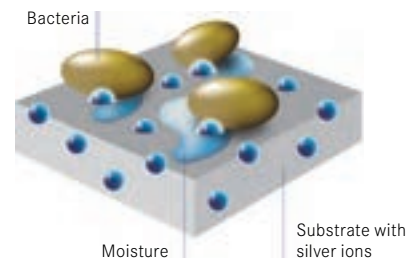

Active biocidal substance: silver ions.
The silver ion locates the bacteria via the moisture and deactivates it.





Stainless Steel

Franke stainless steel sinks are made from premium quality chrome nickel steel, which look stunningly beautiful and is highly resistant to staining, rust and corrosion – plus it won't chip, craze, flake or break. It's the most popular material – and for good reason: Stainless steel has a timeless quality that sits beautifully in a traditional or contemporary style kitchen, offering stunning good looks and a durability that helps keep it looking at its best for years.

Franke offers sinks in a selection of stainless steel finishes, so whether you prefer the more reflective qualities of the polished finish or the more subtle look of the silk or brushed finishes, which give a more matt sheen, there is a stainless steel solution for you.



Silk



Matt Brushed



Polished

Note: Stainless Steel as a material is not scratch resistant. The more it gets used, a patina will develop over time.



Ceramic

Ceramic sinks have been a popular choice for years and combine well with a variety of work surfaces such as wood, glass and granite. Ceramic sinks have a smooth, impervious surface, which is resistant to all standard household chemicals. It's a very hardwearing choice that stands up to heat, staining and impacts with ease.

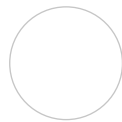

Solid White



Matt Pearl
Grey

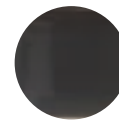

Graphite



Tectonite

Exceptional resistance to heat, shock and impact, coupled with unique design freedom makes Tectonite sinks the ultimate choice for hardworking, stylish kitchens. New technology represents a giant leap forward for synthetic materials, whilst allowing for exciting minimalist designs in the most popular colour options.

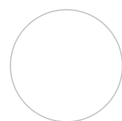

Polar White



Coffee



Carbon Black

Taps worth talking about

Explore endless shape, line and contour possibilities to make an ordinary kitchen something special. The Franke tap range provides your kitchen with a focal point – and in some cases, a talking point. Featuring cutting edge design and a whole host of innovative features to enhance your lifestyle – from filtered cold water, to Instant Boiling Water – the range spans the entire spectrum of form and function.

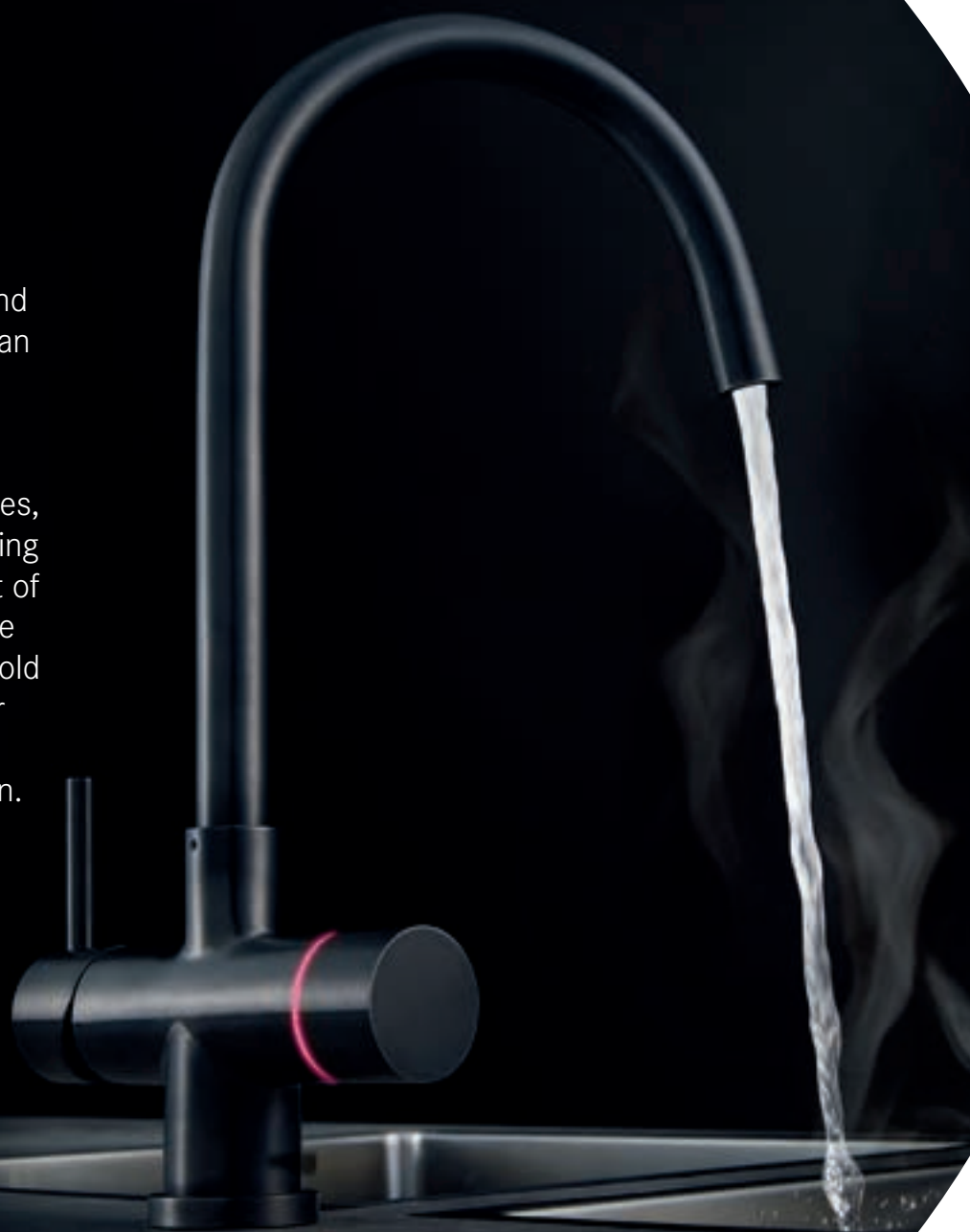

Minerva Electronic 4-in-1 in Industrial Black Instant Boiling Water Tap



Instant boiling water taps

Get instant 100°C water at your fingertips, straight from your kitchen tap, with Franke boiling water taps. Perfect for making drinks or getting meals underway in a flash, they combine safety, stylish design and cutting-edge technology.



Mixer taps

Our wonderful range spans the entire spectrum of design, from traditional bridge taps to the chic practicality of a chef's style tap. Many have features to simplify meal preparation and kitchen tasks so that the everyday can become wonderful.



Filtered water taps

Our Vital and FilterFlow taps deliver hot, cold and filtered water in high style. No need to buy bottled water and you can even do your bit for the environment.

Tap flow rates explained

Before choosing your Franke tap it is essential to check whether you have a high or low pressure water system.

If your property has a low pressure water system you will need to check the flow rating of the taps before you make a purchase. If you install a tap with a low flow rating into a low pressure water system you may be disappointed with the flow of water from your tap. In these instances it will be difficult to achieve a suitable mixed flow of water through the tap as the cold mains water is delivered at a higher pressure and will overpower the weaker hot water pressure.

If you have a high pressure system in your home, such as a combi-boiler or pumped system, you should be able to choose from the full range of taps in our range. We strongly recommend that your plumber or installer checks the water pressure in your home before making a purchase.

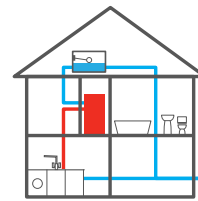

Low pressure (Gravity-fed system)

You have a cold water tank in your attic and a hot water tank in your airing cupboard. You should choose taps which state they are suitable for a low pressure system.

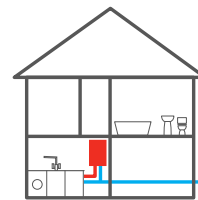

High pressure (Combi-boiler system)

You have a boiler unit but no hot water cylinder. The boiler unit is usually found in the kitchen and delivers hot water on demand. You should be able to choose from most of our taps.

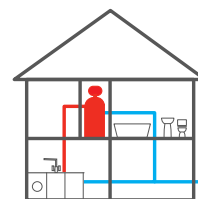

High pressure (Pumped system)

You have a hot water cylinder with an expansion vessel on top (often called Megaflo), usually found in the airing cupboard, but you do not have a cold water tank. You should be able to choose any of our taps.



This symbol indicates the tap will work with a low pressure system, delivering at least 4 litres per minute of hot water at 0.3 bar pressure.

Image shows Mythos Plus MYX 251 TPL SS Sink with Icon Pull-Out Double Jet Shower



Stainless Steel Inset Sinks

50 Year
Guarantee

The newly transformed Mythos Plus sinks combine both design and functionality, thanks to an elegant R10 corner radius and stylish rounded waste cover which sits flush with the sink. The modern and warm design combined with distinctive product features make these products desirable for anyone looking for a top of the range Stainless Steel Franke sink. If you have a flair for cooking, why not take a look at the Mythos Plus accessories to really create a workstation fit for a professional chef!

All sinks come with a 50 year guarantee against manufacturing defects, so you can have peace of mind these products are here to stay!



Mythos Plus

Stainless Steel sink



- Slim-Top edge
- Hygienic overflow offers versatility for cleaning
- Push-button pop up waste
- Replaces the Frames by Franke sink range



Image shows MYX 211 Sink.
Tap not available in the UK.

SUGGESTED WDU
Turbo Elite TE-75
STAINLESS STEEL
Silk



Mythos Plus MYX 210 SS

Sink:

Plumbing Kit Compatible:

Siphon 1



Mythos Plus MYX 210 TPL SS

Sink:

Plumbing Kit Compatible:

Siphon 1



Mythos Plus MYX 211 SS

Sink:

Plumbing Kit Compatible:

Siphon 1



Mythos Plus MYX 211 TPL SS

Sink:

Plumbing Kit Compatible:

Siphon 1

INCLUDED ACCESSORIES

Black Glass Chopping Board
112.0355.965



Mythos Plus MYX 251 TPL SS

Sink:

Plumbing Kit Compatible:

Siphon 2

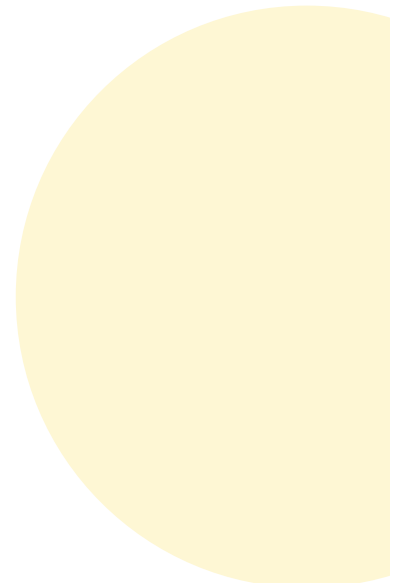



Image shows MYX 211 Sink.
Tap not available in the UK.

Mythos Plus

Every Mythos Plus sink has a super slim steel frame and is fitted either flush or in slim profile. All come with a 50 year guarantee against manufacturing defects.

Turn your sink into a multi-functional workstation with the addition of clever accessories that combine function and technology.

This is how good design works: this Stainless Steel Rollamat belongs on every sink and serves as the perfect draining board. Moreover, it hardly takes up any storage space as it can be rolled up!



Tap not available in the UK.

Accessories

Turn your Mythos Plus sink into a multi-functional work station with the addition of clever accessories that combine function and technology. From items that aid a hygienic kitchen, to those that make preparation a joy, you'll find accessories to surprise and delight!

Mobile Drainer:
112.0602.288



Stainless Steel Strainer Bowl:
112.0599.107



Mythos Chopping Board:
112.0591.082



Rollamat:
112.0591.081



Silicon Chopping Board Soft Pad:
112.0342.598

- Silicon mat positions on the glass chopping board
- Prevents knives from going blunt
- Non slip



Gastronorm

Designed to fit perfectly over the sink to make cooking prep a breeze.



Gastronorm Adaptor:
112.0357.743



Gastronorm Strainer Bowl:
112.0384.902



Gastronorm Tray:
112.0384.903

Box Center

Stainless Steel sink



- Also available in undermount models - see page 48
- Hygienic overflow
- Push-button pop up waste
- All accessories are included
- Slim-Top
- Shown with Zelus Chrome/Spring tap



Box Center
BWX 220 54-27

Sink:

Plumbing Kit Compatible:
 Siphon 2

SUGGESTED WDU
 Turbo Elite TE-75

STAINLESS STEEL
 Matt Brushed



INCLUDED ACCESSORIES

Stainless Steel Strainer Bowl



Food Preparation Platter



Frame Cover



Wire Rack



Chopping Board



Knife Holder



Knife Set



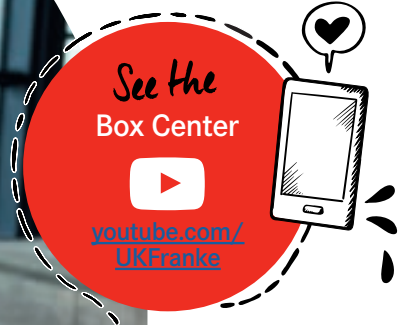

EASILY ACCESSIBLE
ACCESSORIES
 integrated in the
MAIN BOWL



**Box Center
 BWX 220 41-27**

Sink:

Plumbing Kit Compatible:
 Siphon 2

SUGGESTED WDU
 Turbo Elite TE-75

STAINLESS STEEL
 Matt Brushed



**Box Center BWX Compartment Bowl
 220 110-27**

Sink:

Plumbing Kit Compatible:
 Siphon 1

Slimtop/flushmount on this model

Note: Accessories fit laterally across the main bowl.

Studio

Stainless Steel sink

- Standard edge rolled over to meet the worktop
- Requires 900 x 900 corner base cabinet
- Shown with Davos J Chrome tap



Studio STX 621-E

Sink:

- Recommended **A**

Plumbing Kit Compatible:

Siphon 2

SUGGESTED WDU
Turbo Elite TE-75

STAINLESS STEEL
Silk

ACCESSORIES

A
Stainless Steel Strainer Bowl:
112.0057.850



Mythos

Stainless Steel sink

- Also available in undermount - see page 52
- Hygienic overflow offers versatility for cleaning.
- Shown with Zelus Chrome/Spring tap.
- Round flush waste cover gives Mythos a smoother base and protects pots and glasses.
- Exclusive Mythos MYX accessories.

SUGGESTED WDU
Turbo Elite TE-75

STAINLESS STEEL
Brushed



Seamless 6mm rim
to integrate perfectly
with the work surface

A TIGHTER
BOWL RADIUS



450

Mythos MYX 210-34

Sink:

- Recommended **A B C D**

Plumbing Kit Compatible:

Siphon 1



550

Mythos MYX 210-45

Sink:

- Recommended **A B C D**

Plumbing Kit Compatible:

Siphon 1



600

Cabinet walls
may require
modification

Mythos MYX 210-55

Sink:

- Recommended **A B C D**

Plumbing Kit Compatible:

Siphon 1



800

Mythos MYX 210-70

Sink:

- Recommended **A B C D**

Plumbing Kit Compatible:

Siphon 1

ACCESSORIES

A

Rollamat:
112.0591.081



B

Stainless Steel Strainer Bowl:
112.0599.107



C

Mythos Chopping Board:
112.0591.082



D

Mobile Drainer:
112.0602.288



Maris

Stainless Steel sink

- Also available in undermount - see page 56
- Hygienic overflow offers versatility for cleaning
- Shown with Mythos MTX Chrome tap

SUGGESTED WDU
Turbo Elite TE-50

STAINLESS STEEL
Matt Brushed



THIS
MATT BRUSHED
FINISH
ensures a tasteful
and CLEAN
AESTHETIC



Maris MRX 210-19

Sink:

- Recommended A B C D

Plumbing Kit Compatible:

Siphon 1

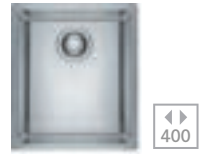

Maris MRX 210-34

Sink:

- Recommended A B C D

Plumbing Kit Compatible:

Siphon 1



Maris MRX 210-45

Sink:

- Recommended A B C D

Plumbing Kit Compatible:

Siphon 1



Maris MRX 210-55

Sink:

- Recommended A B C D

Plumbing Kit Compatible:

Siphon 1

ACCESSORIES

A
Rollamat 42:
112.0030.882



B
Stainless Steel Strainer Bowl:
112.0057.850



C
Chopping Board:
112.0530.071



D
Mobile Drainer:
112.0188.651





Image shows Maris MRX 210-70 Sink with Zelus Chrome/Spring Tap



800

Maris MRX 210-70

Sink:

- Recommended **A B C D**

Plumbing Kit Compatible:

Siphon 1



800

Maris MRX 220 34-34

Sink:

- Recommended **A B C D**

Plumbing Kit Compatible:

Siphon 2



600

Maris MRX 260 34-19

Sink:

- Recommended **A B C D**

Plumbing Kit Compatible:

Siphon 2



Epos

Stainless Steel sink



- Swiss edge profile
- Hygienic overflow offers versatility for cleaning
- Push-button pop up waste
- Shown with Athena Chrome tap



SUGGESTED WDU
Turbo Elite TE-50

STAINLESS STEEL
Silk



Epos EOX 611

Sink:

- Recommended **A** **B** **C**

Plumbing Kit Compatible:

Siphon 1



Epos EOX 651

Sink:

- Recommended **A** **B**

Plumbing Kit Compatible:

Siphon 2

ACCESSORIES

A
Stainless Steel Strainer Bowl:
112.0017.788



B
Stainless Steel Drainer Basket:
112.0007.664



C
Chopping Board:
112.0014.124



Neptune

Stainless Steel sink

- Slim-Top edge
- Shown with Athena Chrome tap



SUGGESTED WDU
Turbo Elite TE-50

STAINLESS STEEL
Silk



Neptune NEX 211

Sink:



Neptune NEX 251

Sink:

- Recommended **A** **B**

Plumbing Kit Compatible:

Siphon 2

ACCESSORIES

A
Stainless Steel Strainer Bowl:
112.0040.691



B
Rollamat 44:
112.0080.355



Maris

Stainless Steel sink

- Slim-Top edge
- Hygienic overflow offers versatility for cleaning
- Shown with Athena Chrome tap



SUGGESTED WDU
Turbo Elite TE-50

Silk



Maris MRX 211

Sink:

- Recommended **A** **B**

Plumbing Kit Compatible:
Siphon 1



Maris MRX 251

Sink:

- Recommended **A** **B** **C**

Plumbing Kit Compatible:
Siphon 2

ACCESSORIES

A
Chopping Board:
112.0193.082



B
Rollamat 36:
112.0075.642



C
Stainless Steel
Strainer Bowl:
112.0057.850



Galassia

Stainless Steel sink

- Standard edge rolled over to meet the worktop
- Shown with Zurich Chrome tap



SUGGESTED WDU
Turbo Elite TE-50

Silk



Galassia GAX 611

Sink:

- Recommended **A** **B**

Plumbing Kit Compatible:
Siphon 1



Galassia GAX 621*

Sink:

- Recommended **A** **B**

Plumbing Kit Compatible:
Siphon 2

*Model will not accommodate taps
with a base over 55mm

ACCESSORIES

A
Stainless Steel
Strainer Bowl:
112.0057.850



B
Bamboo Chopping Board:
112.0595.334



Argos

Stainless Steel sink

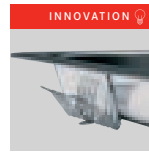

- Swiss edge profile
- Hygienic overflow offers versatility for cleaning
- Shown with Athena Chrome tap

SUGGESTED WDU
Turbo Elite TE-50

Finish
Matt Brushed



Argos AGX 611-78

Sink:

- Recommended **B** **C**

Plumbing Kit Compatible:

Siphon 1



Argos AGX 611-86

Sink:

- Recommended **B** **C**

Plumbing Kit Compatible:

Siphon 1



Argos AGX 611-100

Sink:

- Recommended **B** **C**

Plumbing Kit Compatible:

Siphon 1



Argos AGX 651

Sink:

- Recommended **A** **B** **C**

Plumbing Kit Compatible:

Siphon 2

ACCESSORIES

A
Stainless Steel Strainer Bowl:
112.0041.519



B
Chopping Board:
112.0193.082



C
Drainer Basket:
112.0007.664



Spark

Stainless Steel sink

- Standard edge rolled over to meet the worktop
- Shown with Athena Chrome tap



SUGGESTED WDU
Turbo Elite TE-50

STAINLESS STEEL
Silk



Spark SKX 611-86

Sink:

- Recommended **A** **B**

Plumbing Kit Compatible:

Siphon 1



Spark SKX 651

Sink:

- Recommended **A** **B**

Plumbing Kit Compatible:

Siphon 2

ACCESSORIES

A

Stainless Steel Strainer Bowl:
112.0461.942



B

Chopping Board:
112.0271.449



Image shows Spark SKX 651 Sink with Athena Chrome Tap

Antea

Stainless Steel sink

- Standard edge rolled over to meet the worktop
- Shown with Athena Chrome tap



SUGGESTED WDU
Turbo Elite TE-50

STAINLESS STEEL
Polished with Satin bowl



Antea AZN 611-86

Sink:

- Recommended **B**

Plumbing Kit Compatible:

Siphon 1



Antea AZN 611-100

Sink:

- Recommended **B**

Plumbing Kit Compatible:

Siphon 1



Antea AZN 651

Sink:

- Recommended **A B**

Plumbing Kit Compatible:

Siphon 2

ACCESSORIES

A

Stainless Steel Strainer Bowl:
112.0461.942



B

Chopping Board:
112.0271.449



Utility

Stainless Steel sink

- Standard edge rolled over to meet the worktop
- Features angled front rubbing board
- Not suitable for solid surface installation
- Shown with Davos J SilkSteel tap



SUGGESTED WDU

Turbo Elite TE-75

STAINLESS STEEL

Brushed



Utility UTX 610

Sink:

Plumbing Kit Compatible:

Siphon 1

Rotondo

Stainless Steel sink

- Standard edge rolled over to meet the worktop
- Shown with Davos J SilkSteel tap



SUGGESTED WDU

Turbo Elite TE-75

STAINLESS STEEL

Brushed



Rotondo RBX 610

Sink:

- Recommended **A** **B** **C**

Plumbing Kit Compatible:

Siphon 1

Rondo

Stainless Steel sink

- Ideal preparation area sink
- Shown with Davos J SilkSteel tap



STAINLESS STEEL

Brushed



Rondo RNX 610

Sink:

Plumbing Kit Compatible:

Siphon 1

ACCESSORIES

A

Stainless Steel
Drainer Basket:
112.0050.639



B

Rotondo RBX 604
Drainer:
101.0050.182



C

Bamboo Chopping
Board:
112.0154.645





Image shows Urban UBG 651 in Sage Grey with Active Plus Pull-Out Spray in Brass

Fragranite Inset Sinks treated with **Sanitized**[®] and **Tectonite**

50 Year Guarantee

Durable, versatile Fragranite offers a host of practical and aesthetic benefits. The surface's rich colour will not stain, mark or fade over time. Plus being heat, impact and scratch resistant, it's perfect for busy family homes. What's more Fragranite's Sanitized[®] coating reduces bacteria and microbe growth by 99%, helping keep your sink hygienic and clean.

Similarly, Tectonite sinks have a unique texture and granite-like appearance and are available in a range of colours. Heat resistant up to 300°C, Tectonite's coated surface is protected against stains and bacteria.

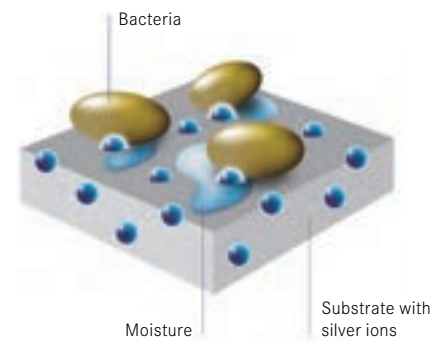

Contains biocidal substance: silver phosphate glass. The silver ion locates the bacteria via the moisture and deactivates it.

Maris

Fragranite sink

- Shown with Athena Chrome tap



SUGGESTED WDU

Turbo Elite TE-50

FRAGRANITE SILKSHEEN

- Polar White
- Coffee
- Oyster **NEW**
- Stone Grey
- Onyx
- Matt Black **NEW**



Maris MRG 611

Sink:

- Recommended **B C**
- Plumbing set connector included

Plumbing Kit Compatible:

Siphon 1



Maris MRG 651

Sink:

- Includes **A**
- Recommended **B C**
- Plumbing set connector included

Plumbing Kit Compatible:

Siphon 2

INCLUDED ACCESSORIES

A

Stainless Steel Strainer Bowl
112.0064.235



EXTRA COST

B

Rollamat 36:
112.0075.642



C

Sliding Glass Board:
112.0595.334



Image shows Maris MRG 651 in Oyster with Maris Pull-Out Spray tap.

Urban

Fragranite sink



- The first Fragranite sink to feature easy fit Slim-Fix clips
- Hygienic overflow offers versatility for cleaning
- Shown with Zelus Chrome/Spring tap

SINKS CAN BE
**FLUSHMOUNTED
 OR INSET**
 as the outer edge
 is vertical



SUGGESTED WDU	
Turbo Elite TE-50	
FRAGRANITE SILKSHEEN	
	Polar White
	Coffee
	Oyster NEW
	Stone Grey
	Graphite
	Onyx
	Matt Black NEW
	Sage Grey
	Orion Grey
	Denim Grey



Urban UBG 611-86

Sink:

- Recommended **A** **B**

Plumbing Kit Compatible:

Siphon 1



Urban UBG 611-100

Sink:

- Recommended **A** **B**

Plumbing Kit Compatible:

Siphon 1

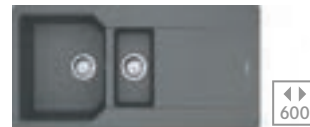

Urban UBG 651

Sink:

- Recommended **A** **B**

Plumbing Kit Compatible:

Siphon 2

THE FIRST FRAGRANITE SINK TO FEATURE SLIM-FIX® CLIPS FOR EASIER INSTALLATION!

ACCESSORIES

A
Synthetic Strainer Bowl:
 112.0538.950



B
Chopping Board:
 112.0595.334





Centro
Fragranite sink

- Hygienic overflow offers versatility for cleaning
- Large sink bowl and compact drainer
- Shown with Hestia J SilkSteel tap

SUGGESTED WDU
Turbo Elite TE-50



FRAGRANITE SILKSHEEN	
	Polar White
	Coffee
	Oyster
	Stone Grey
	Onyx
	Matt Black NEW



Centro CNG 611-78 XL

Sink:

- Recommended **A** **B** **C**

Plumbing Kit Compatible:

Siphon 1



ACCESSORIES

A
Strainer Bowl:
112.0512.280



B
Mobile Drainer:
112.0188.651



C
Chopping Board:
112.0595.334



Basis

Fragranite sink

- Shown with Athena Chrome tap

SUGGESTED WDU
Turbo Elite TE-50



FRAGRANITE SILKSHEEN

	Polar White
	Coffee
	Oyster NEW
	Stone Grey
	Onyx

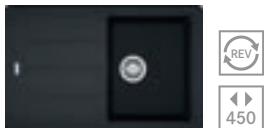

Basis BFG 611-78

Sink:

- Recommended **A** **C**

Plumbing Kit Compatible:
Siphon 1

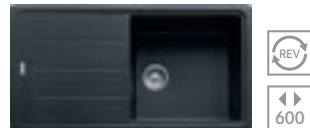

Basis BFG 611-97

Sink:

- Recommended **A** **C**

Plumbing Kit Compatible:
Siphon 1



Basis BFG 651

Sink:

- Recommended **A** **B** **C**
- Plumbing set connector included

Plumbing Kit Compatible:
Siphon 2

ACCESSORIES

A
Chopping Board:
112.0595.334



B
Stainless Steel Strainer Bowl:
112.0250.014



C
Rollamat 30:
112.0256.867



Antea

Fragranite sink

- Shown with Zurich Chrome tap



SUGGESTED WDU

Turbo Elite TE-50

FRAGRANITE SILKSHEEN

Polar White

Coffee

Oyster **NEW**

Stone Grey **NEW**

Onyx



Antea AZG 611-78

Sink:

- Recommended **B**
- Plumbing set connector included

Plumbing Kit Compatible:

Siphon 1



Antea AZG 651

Sink:

- Recommended **A B**
- Plumbing set connector included

Plumbing Kit Compatible:

Siphon 2



Antea AZG 621

Sink:

- Recommended **B**
- Plumbing set connector included

Plumbing Kit Compatible:

Siphon 2

A

Stainless Steel Strainer Bowl:
112.0464.521



B

Chopping Board:
112.0595.334





Image shows Orion OID 651 Sink with Neptune Smoked Chrome Tap.

Orion

Tectonite sink

- Hygienic overflow offers versatility for cleaning
- Shown with Athena Chrome tap



SUGGESTED WDU

Turbo Elite TE-50

TECTONITE

Polar White

Coffee

Carbon Black



Orion OID 611-94

Sink:

- Recommended **A**

Plumbing Kit Compatible:

Siphon 1



Orion OID 651

Sink:

- Recommended **A**

Plumbing Kit Compatible:

Siphon 2

ACCESSORIES

A
Chopping Board:
112.0595.334





Image shows Arcana AHK 651 sink.
Tap not available in the UK

Ceramic Inset Sinks

Ceramic sinks combine beautifully with a variety of work surfaces such as wood, glass and granite. It's no wonder they have been a popular choice for years and their smooth, impervious surface is resistant to all standard household chemicals, making them perfect for modern, hardworking kitchens. It's a durable choice that stands up to heat, staining and impact with ease; so there's much more to ceramic than silky smooth good looks.



This logo indicates the sink has been produced in partnership with leading ceramic brand Villeroy & Boch.



Elba

Ceramic sink



- Ceramic sink measurements may vary +/-1% due to the firing process
- We recommend that the sink should be used as a template in all cases
- Extended flange required if installing a waste disposal unit* - see page 108
- Shown with Zurich Chrome tap



SUGGESTED WDU
Turbo Elite TE-50

CERAMIC
Gloss White

Galassia

Ceramic sink

- Ceramic sink measurements may vary +/-5% due to the firing process
- We recommend that the sink should be used as a template in all cases
- Extended flange required if installing a waste disposal unit*- see page 108
- Shown with Zurich Chrome tap



SUGGESTED WDU
Turbo Elite TE-50

CERAMIC
Gloss White



Elba ELK 611

Sink:

500mm cabinet wall may require modification to accommodate overflow

Plumbing Kit Compatible:
Siphon 1



Elba ELK 651

Sink:

In left hand format the overflow will be situated on the front face of the half bowl

Plumbing Kit Compatible:
Siphon 2



Galassia GAK 611

Sink:

In right hand mode, the overflow will be situated at the front of the bowl

Plumbing Kit Compatible:
Siphon 1



Galassia GAK 651

Sink:

Plumbing Kit Compatible:
Siphon 2

*NB: Batch feed WDU's are not compatible with ceramic sinks.

*NB: Batch feed WDU's are not compatible with ceramic sinks.

Arcana

Ceramic sink



- Ceramic sink measurements may vary +/-1% due to the firing process
- We recommend that the sink should be used as a template in all cases
- Extended flange required if installing a waste disposal unit* - see page 108
- Shown with Eiger Chrome tap



SUGGESTED WDU
Turbo Elite TE-75

CERAMIC
Gloss White



Arcana AHK 611

Sink:

Plumbing Kit Compatible:
Siphon 1



Arcana AHK 651

Sink:

Plumbing Kit Compatible:
Siphon 2

*NB: Batch feed WDU's are not compatible with ceramic sinks.



Image shows Arcana AHK 611 Sink with Eiger Chrome Tap

Belfast

Ceramic sink



- Ceramic sink measurements may vary +/-1% due to the firing process
- We recommend that the sink should be used as a template in all cases
- Extended flange required if installing a waste disposal unit*- see page 108
- Shown with Eiger Chrome tap



SUGGESTED WDU
Turbo Elite TE-75

Gloss White



Belfast VBK 710

Sink:

Plumbing Kit Compatible:

Siphon 1



Belfast VBK 720

Sink:

Plumbing Kit Compatible:

Siphon 2



Belfast BAK 710

Sink:

Plumbing Kit Compatible:

Siphon 1

Not Franke by Villeroy & Boch
Not compatible with WDU

*NB: Batch feed WDU's are not compatible with ceramic sinks.



Image shows Box Center 160 34-17 Sink with the Vital 3-in-1 Filter Tap Semi-Pro

Stainless Steel Undermount Sinks

It's your kitchen, so why should you compromise on style or performance? Stainless steel undermounts are particularly easy to clean and exceptionally durable, so luckily you don't have to.

They give a flawless, uninterrupted look to your kitchen and for solid work surfaces such as granite and wood, a stainless steel undermount sink clips directly underneath the surface to provide a work area that is practical and hygienic. These sinks not only look beautiful, but are resistant to staining, chipping, rust and corrosion. With a long history as the world's premium brand in kitchen sinks, you can be confident that you are buying a quality product with premium features. In fact, we are so confident about the quality of manufacture that we offer a 50-year guarantee on all Franke sinks.

Please note: The majority of 1.5 bowl sinks have a template which gives a flange reveal to accommodate accessories. We recommend that you speak to your worktop fabricator to ensure whether or not this is required.



Box Center

Stainless Steel Undermount sink

- Available in inset/flushmount models - see page 24
- Hygienic overflow offers versatility for cleaning
- All accessories are included
- Shown with Zelus Chrome/Spring tap

SUGGESTED WDU

Turbo Elite TE-75

Matt Brushed



Box Center BWX
Compartment Bowl 220 110-27

Sink:

Plumbing Kit Compatible:

Siphon 1



Box Center BWX 120 41-27

Sink:

Plumbing Kit Compatible:

Siphon 2

Note: Accessories fit laterally across main bowl.

EASILY ACCESSIBLE
ACCESSORIES
integrated in the
MAIN BOWL

INCLUDED ACCESSORIES

Stainless Steel
Strainer Bowl



Food Preparation
Platter



Frame Cover



Wire Rack



Chopping Board



Knife Holder



Knife Set





Image shows BWX 220 110-27 Compartment Bowl with Pescara Pull Down Spray and Vital Single Dispense Chrome Taps.

Box

Stainless Steel Undermount/Inset sink

- Hygenic overflow offers versatility for cleaning
- Can be inset or undermount
- Compatible with waste disposal unit
- Shown with Zelus Chrome/Spring tap

SUGGESTED WDU

Turbo Elite TE-50

Matt Brushed



NEW



Box BXX 110 16

Sink:

- Recommended **A B C D E**

Plumbing Kit Compatible:

Siphon 1



Box BXX 110 40

Sink:

- Recommended **A B C D E**

Plumbing Kit Compatible:

Siphon 1



Box BXX 110 50

Sink:

- Recommended **A B C D E**

Plumbing Kit Compatible:

Siphon 1



Box BXX 110 54

Sink:

- Recommended **A B C D E**

Plumbing Kit Compatible:

Siphon 1

ACCESSORIES

A

Rollamat 44:
112.0080.355

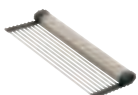

B

Stainless Steel Strainer Bowl:
112.0394.981



C

Mobile Drainer:
112.0188.651



D

Chopping Board:
112.0539.134





Please note: Only one size and design available.

NEW



800

Box BXX 110 68

Sink:

- Recommended **A B C D E**

Plumbing Kit Compatible:

Siphon 1



600

Box BXX 160 34-16

Sink:

- Recommended **A B C D E**

Plumbing Kit Compatible:

Siphon 2

NEW

INTRODUCING YOUR ASSISTANT CHEF

Andy Chef accessories kit works smartly and efficiently with your Franke Box® bowl sink in creating a perfectly organised workstation. The innovative and stylish designer kit features a case, a stainless steel strainer bowl, a walnut chopping board and a chef's knife.

You can store Andy Chef in it's designated place inside the Franke Box® sink or proudly show it off on your kitchen worktop.

E

Andy Chef:
112.0619.946



Mythos

Stainless Steel Undermount sink

- Available in inset/flushmount models - see page 27
- Hygienic overflow offers versatility for cleaning
- Shown with Zelus Chrome/Spring tap
- Round flush waste cover gives Mythos a smoother base and protects pots and glasses
- Exclusive Mythos MYX accessories.

SUGGESTED WDU

Turbo Elite TE-50

Matt Brushed



300

Mythos MYX 110 16

Sink:

Plumbing Kit Compatible:
Siphon 1



450

Mythos MYX 110 34

Sink:

- Recommended A B C D

Plumbing Kit Compatible:
Siphon 1



550

Mythos MYX 110 45

Sink:

- Recommended A B C D

Plumbing Kit Compatible:
Siphon 1



600

Mythos MYX 110 55

Sink:

- Recommended A B C D

Plumbing Kit Compatible:
Siphon 1

Cabinet walls may require modification

NEW ACCESSORIES

A

Rollamat:
112.0591.081



B

Stainless Steel Strainer Bowl:
112.0599.107



C

Mythos Chopping Board:
112.0591.082



D

Mobile Drainer:
112.0602.288



A TIGHTER BOWL RADIUS



800

Mythos MYX 110 70

Sink:

- Recommended **A B C D**

Plumbing Kit Compatible:

Siphon 1



600

Mythos MYX 160 34-16

Sink:

- Recommended **A B C D**

Plumbing Kit Compatible:

Siphon 2



800

Mythos MYX 160 50-16

Sink:

- Recommended **A B C D**

Plumbing Kit Compatible:

Siphon 2



800

Mythos MYX 120 34-34

Sink:

- Recommended **A B C D**

Plumbing Kit Compatible:

Siphon 2



MYTHOS MYX
REPLACES KUBUS
KBX RANGE

Largo

Stainless Steel Undermount sink

- Hygienic overflow offers versatility for cleaning
- Visual shows flush fit installation
- Standard template cut-out for sink is oversized providing flange reveal to allow accessories to fit if required
- Shown with Zelus Chrome/Spring tap

SUGGESTED WDU

Turbo Elite TE-75

STAINLESS STEEL

Silk



500

Largo LAX 110 45

Sink:

- Recommended **A** **E** **F**

Plumbing Kit Compatible:

Siphon 1



600

Largo LAX 110 50

Sink:

- Recommended **A** **F**

Plumbing Kit Compatible:

Siphon 1



600

Largo LAX 110 50-41

Sink:

- Recommended **A** **B** **C** **E** **F**

Plumbing Kit Compatible:

Siphon 1

ACCESSORIES

A

Stainless Steel Drainer Basket:
112.0007.664



B

Stainless Steel Strainer Bowl:
112.0175.520



C

Maple Chopping Board:
112.0014.124



For Franke,  BEING ORDINARY.
 IS NOT GOOD ENOUGH. 
 SO LET'S LET EVERYONE ELSE BE
ORDINARY
 while we... 

MAKE IT WONDERFUL



Largo LAX 120 45-30

Sink:

- Recommended **D** **E**

Plumbing Kit Compatible:

Siphon 2



Largo LAX 120 36-36

Sink:

- Recommended **D** **E**

Plumbing Kit Compatible:

Siphon 2



Largo LAX 160 36-16

Sink:

- Recommended **D** **E**

Plumbing Kit Compatible:

Siphon 2

ACCESSORIES

D
 Mobile Drainer(342x430mm):
 112.0188.651

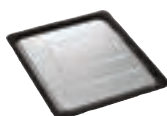

E
 Rollamat 40:
 112.0050.988



F
 Mobile Drainer (333x417mm):
 112.0188.653

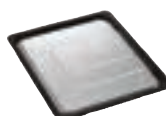

Maris

Stainless Steel Undermount sink

- Available in undermount or inset models - see page 28
- Hygienic overflow offers versatility for cleaning
- Shown with Mythos MTX Chrome tap
- DWG/DWF cut out files are available to download from our website

SUGGESTED WDU

Turbo Elite TE-50

Matt Brushed



THIS
MATT BRUSHED
FINISH
ensures a tasteful
and **CLEAN**
AESTHETIC



300

Maris MRX 110-19

Sink:

- Recommended **A B C D**

Plumbing Kit Compatible:

Siphon 1



400

Maris MRX 110-34

Sink:

- Recommended **A B C D**

Plumbing Kit Compatible:

Siphon 1



550

Maris MRX 110-45

Sink:

- Recommended **A B C D**

Plumbing Kit Compatible:

Siphon 1



800

Maris MRX 110-55

Sink:

- Recommended **A B C D**

Plumbing Kit Compatible:

Siphon 1

ACCESSORIES

A

Rollamat 42:
112.0030.882



B

Stainless Steel Strainer Bowl:
112.0057.850



C

Chopping Board:
112.0530.071



D

Mobile Drainer:
112.0188.651





Image shows Maris Undermount MRX 110-70 Sink with Maris Pull-Out Spray in Chrome.



800

Maris MRX 110-70

Sink:

- Recommended **A B C D**

Plumbing Kit Compatible:

Siphon 1



800

Maris MRX 120 34-34

Sink:

- Recommended **A B C D**

Plumbing Kit Compatible:

Siphon 2



800



Maris MRX 160 34-19

Sink:

- Recommended **A B C D**

Plumbing Kit Compatible:

Siphon 2

Ariane

Stainless Steel Undermount sink

- Hygienic overflow offers versatility for cleaning
- Visual shows flush fit installation
- Standard template cut-out for sink is oversized providing flange reveal to allow accessories to fit if required
- Shown with Athena Chrome tap

SUGGESTED WDU

Turbo Elite TE-50

STAINLESS STEEL

Silk



300

Ariane ARX 110 17

Sink:

Plumbing Kit Compatible:

Siphon 1



300

Ariane ARX 110 17D

Sink:

- Recommended

Plumbing Kit Compatible:

Siphon 1



500

Ariane ARX 110 33

Sink:

- Recommended **B C**

Plumbing Kit Compatible:

Siphon 1



500

Ariane ARX 110 35

Sink:

- Recommended **A B C**

Plumbing Kit Compatible:

Siphon 1

ACCESSORIES

A

Stainless Steel Drainer Basket:
112.0007.664



B

Chopping Board:
112.0035.622



C

Rollamat 40:
112.0050.988





Image shows Rollamat Accessory.

Rotondo

Stainless Steel Undermount sink

- Shown with Zelus Chrome/Spring tap



Ariane ARX 160

Sink:

- Recommended A B C

Plumbing Kit Compatible:
Siphon 2



Ariane ARX 160D

Sink:

- Recommended A B C

Plumbing Kit Compatible:
Siphon 2



Rotondo RUX 110

Sink:

- Recommended A B C D

Plumbing Kit Compatible:
Siphon 1

SUGGESTED WDU
Turbo Elite TE-75

STAINLESS STEEL
Silk

ACCESSORIES

A

Drainer Basket White:
112.0050.254



B

Stainless Steel Drainer Basket:
112.0050.639



C

Bamboo Chopping Board:
112.0154.645



D

Rollamat 40:
112.0050.988





Image shows Kubus KBK 160 Ceramic Sink and Mythos MTX Chrome Tap.

Fragranite & Ceramic Undermount Sinks

Wonderful spaces should simply flow. With undermount sinks, there is nothing to break the smooth flow of your solid granite or wood worksurface. A granite undermount sink provides a subtle complement to your kitchen design. Alternatively, create a bold contrast to granite surfaces with the striking look of a ceramic sink or add a splash of colour with hard, durable Tectonite. Either option represents a hardwearing choice that turns a kitchen into a work area that's a pleasure to be in.

Please note: The majority of 1.5 bowl sinks have a template which gives a flange reveal to accommodate accessories. We recommend that you speak to your worktop fabricator to ensure whether or not this is required.

Fresno

Fragranite Undermount sink



- Hygienic overflow offers versatility for cleaning
- Exceptionally hard wearing
- Hidden waste with flush cover
- Shown with Pescara Semi-Pro XL tap



An ultra contemporary style with trendy colours and texture

FRAGRANITE SILKSHEEN	
	Polar White
	Coffee
	Oyster
	Onyx
	Stone Grey
	Matt Black NEW

SUGGESTED WDU
Turbo Elite TE-75



ROLLAMAT fits Perfectly ON SINK LEDGE

Fresno FSG 111

Sink:

- Includes **A**
- Recommended **B** **C**

Plumbing Kit Compatible:

Siphon 1

Please note:
We would recommend that single side lever or top side lever style taps are fitted with this sink, given the position of the tap platform.



Image shows Fresno FSG 111 Matt Black Sink. Tap not available in the UK.

INCLUDED ACCESSORIES

A
Rollamat FSG

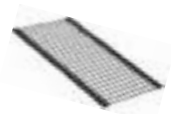

EXTRA COST

B
Stainless Steel Strainer Bowl:
112.0066.060



C
Drainer Grid:
112.0479.069





Image shows Kubus KNG 110 52 Polar White Sink with an Atlas Neo tap.

Kubus KNG

Fragranite Undermount sink

- Hygienic overflow offers versatility for cleaning
- Exceptionally hard wearing
- Accessories ledge integrates accessories seamlessly with sink
- Hidden waste with flush cover
- Shown with Mythos MTX Chrome tap

SUGGESTED WDU

Turbo Elite TE-75

FRAGRANITE SILKSHEEN

- Polar White
- Coffee
- Oyster **NEW**
- Onyx
- Stone Grey
- Matt Black **NEW**



ROLLAMAT
fits Perfectly
**ON SINK
LEDGE**



450

Kubus KNG 110 37

Sink:

- Recommended **A B C**

Plumbing Kit Compatible:

Siphon 1



600

Kubus KNG 110 52

Sink:

- Recommended **A B C**

Plumbing Kit Compatible:

Siphon 1

POP UP WASTE INCLUDED



800

Kubus KNG 110 62

Sink:

- Recommended **A B C**

Plumbing Kit Compatible:

Siphon 1

Please note:
We would recommend that single side lever or top side lever style taps are fitted with this sink, given the position of the tap platform.



800

Kubus KNG 120

Sink:

- Recommended **A B C**

Plumbing Kit Compatible:

Siphon 2

ACCESSORIES

A

Rollamat:
112.0256.867



B

Stainless Steel Strainer Bowl:
122.0066.060



C

Chopping Board:
112.0511.888



Kubus

Fragranite Undermount sink

- Hygienic overflow offers versatility for cleaning
- Exceptionally hard wearing
- Shown with Mythos MTX Chrome tap

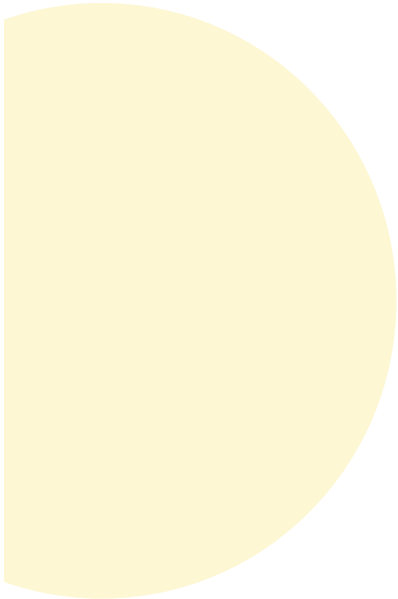

SUGGESTED WDU
Turbo Elite TE-75

FRAGRANITE SILKSHEEN	
	Polar White
	Coffee
	Onyx
	Oyster
	Stone Grey



400

Kubus KBG 110 34

Sink:

- Recommended **A B C**

Plumbing Kit Compatible:

Siphon 1



600

Kubus KBG 110 50

Sink:

- Recommended **A B C**

Plumbing Kit Compatible:

Siphon 1



900

Kubus KBG 110-70

Sink:

- Recommended **A B C**

Plumbing Kit Compatible:

Siphon 1



600

Kubus KBG 160

Sink:

- Recommended **A B C**

Plumbing Kit Compatible:

Siphon 2

ACCESSORIES

A

Rollamat 40:
112.0050.988

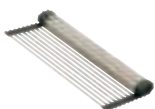

B

Mobile Drainer:
122.0188.651



C

Strainer Bowl:
112.0066.060





Image shows Kubus KBG 110 50 in Onyx.
with Pescara Pull Down XL.





Image shows Kubus KBK 160 ceramic undermount sink. Tap not available in the UK.

Kubus KBK

Ceramic Undermount sink

- Ceramic finish in three colours
- Ceramic sink measurements may vary +/-1% due to the firing process
- We recommend that the sink should be used as a template in all cases
- Extended flange required if installing a waste disposal unit*- see page 108
- Shown with Zelus Chrome/Spring tap

SUGGESTED WDU	
	Turbo Elite TE-75

CERAMIC	
	Gloss White
	Matt Pearl Grey
	Graphite



Kubus KBK 110 40

Sink:

- Recommended **A**

Plumbing Kit Compatible:

Siphon 1



Kubus KBK 110 50

Sink:

- Recommended **A**

Plumbing Kit Compatible:

Siphon 1



Kubus KBK 160

Sink:

- Recommended **A**

Plumbing Kit Compatible:

Siphon 2

- Included 1½" non-sealable basket strainer waste in small bowl
- WDU cannot be fitted in half bowl

*NB: Batch feed WDU's are not compatible with ceramic sinks.

ACCESSORIES

A
Rollamat 40:
 112.0050.988



Franke by V&B

Ceramic Undermount sink



- Gloss white ceramic finish
- Ceramic sink measurements may vary +/-1% due to the firing process
- We recommend that the sink should be used as a template in all cases
- Extended flange required if installing a waste disposal unit* - see page 108
- This sink cannot be fitted with a reveal due to the unglazed flange
- Shown with Eiger Chrome tap

SUGGESTED WDU

Turbo Elite TE-75

CERAMIC

Gloss White



**Franke by Villeroy & Boch
VBK 110 21**

Sink:

- Recommended **A**

Plumbing Kit Compatible:

Siphon 1



**Franke by Villeroy & Boch
VBK 110 33**

Sink:

- Recommended **A**

Plumbing Kit Compatible:

Siphon 1



**Franke by Villeroy & Boch
VBK 110 50**

Sink:

- Recommended **A**

Plumbing Kit Compatible:

Siphon 1



**Franke by Villeroy & Boch
VBK 160**

Sink:

- Recommended **A**

Plumbing Kit Compatible:

Siphon 2

- Included 1½" black plug in small bowl

*NB: Batch feed WDU's are not compatible with ceramic sinks.

ACCESSORIES



Rollamat 40:
112.0050.988





Image shows Kubus KBK 160 ceramic undermount sink. Tap not available in the UK.

Made with fire

Ceramic by Franke is
FIRED FOR 20 HOURS
in a tunnel kiln at
VERY HIGH TEMPERATURES.



This process creates an
EXTREMELY HARD SURFACE,
scratch-resistant, HEAT-PROOF AND
impervious to acids and bleaches.



Image shows Ariane ARX 160 Sink with
Omni 4-in-1 Stainless Steel Instant Boiling Water Tap



Instant Boiling Water Taps - The Ultimate Kitchen Companion

With kitchen design playing a key role in home improvement, the future of the kitchen has arrived with the introduction of instant boiling water taps. Franke Boiling Water taps offer hot, cold and instant 100°C boiling water to save time, energy and water in a single stylish, convenient and space-saving unit.

You can now cook vegetables, create pasta dishes, sterilise babies bottles and make tea or coffee quicker than ever before with 100°C boiling water available instantly. Most 'boiling' tap systems only produce less than 98°C so hot drinks don't taste as good as they should.

Please check your domestic water pressure in relation to the tap operating pressure before purchase.



Each filter lasts around 6 - 9 months and replacing the filter is as easy as changing a lightbulb.



The Franke instant boiling water taps deliver fully boiling 100°C water instantly for the perfect cuppa.



It is important that you change your filter regularly to keep the water free of impurities and fresh to drink. This will also protect the system from harmful debris and deposits.

	Functions	Filtered Cold	100°C Boiling	Mains Cold	Mains Hot
OMNI ORIGINAL & CONTEMPORARY 	4	✓	✓	✓	✓
MINERVA ORIGINAL, MONDIAL & HELIX ELECTRONIC 4-IN-1 	4	✓	✓	✓	✓
MINERVA HELIX & MONDIAL 3-IN-1 	3	✗	✓	✓	✓
MINERVA ORIGINAL 3-IN-1 	3	✗	✓	✓	✓

Minerva 4-in-1 Electronic Range

Minerva
4 in 1
ELECTRONIC

The electronically controlled Minerva 4-in-1 tap delivers 100°C boiling, warm, cold or cold filtered water in an instant.



The Minerva 4-in-1 Electronic features the M-Box

For a faster, flawless installation our popular Minerva 4-in-1 taps now feature the new Franke M-Box. Incorporating a Franke Pro M filter, inlet combination, mixing valve set, gasket set and control box in a single unit, the M-Box tidies pipework and allows for horizontal or vertical installation in as little as 20 minutes.

Pressing in the electronic dial wakes the tap from its safety standby mode when the dial glows white. For 100°C boiling water, select the red light and pressing the dial in twice will automatically dispense 30 seconds worth of water, enough to fill a pan, press three times for 60 seconds. Select blue for cold filtered water and a double press of the dial will dispense cold filtered water for 15 seconds, press three times for 30 seconds. The flow of water in each case can also be controlled manually by turning and holding the dial to give more or less water than the pre-set options. The user can select which mode best suits the task in hand.

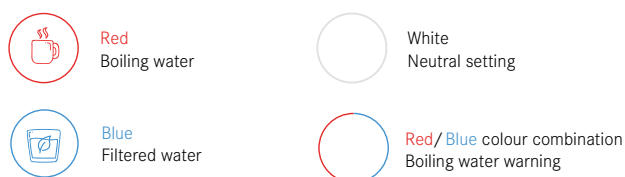

3 NEW COLOURS

Make a statement in your kitchen with one of our three new colours. The taps are solid stainless steel with a long lasting coating keeping the structure of the stainless steel visible. Will you choose the tough Industrial Black, the stand out Champagne Gold or the on-trend Copper? With a choice of 2 models; Mondial L Spout or Helix J Spout, there is always a tap that fits your kitchen style.



Can fit
VERTICALLY
or **HORIZONTALLY**
in your cabinet



Dimensions
of tank below
Width 550mm
Height 142mm
Depth 211mm



Minerva 4-in-1 Electronic



- Electronic touch control
- Dispenses 100°C boiling, cold filtered, hot and cold water
- 5L horizontal tank can be fitted vertically or horizontally
- Easy to install
- 2 year working parts guarantee
- 2 year finish and O-ring guarantee

Minerva Original 4-in-1

FINISH	
	Chrome

Minerva Mondial 4-in-1

FINISH	
	Solid Stainless Steel
	Champagne Gold
	Copper
	Industrial Black

Minerva Helix 4-in-1

FINISH	
	Solid Stainless Steel
	Champagne Gold
	Copper
	Industrial Black



Minerva Helix in Champagne Gold



Minerva Mondial in Champagne Gold



Copper

A TOUCH
of COLOUR



Industrial Black



Solid Stainless Steel



Minerva Original in Chrome

Omni 4-in-1 Range

Omni 4-in-1 delivers not only hot and cold mains water but also cold filtered and 100°C boiling water. Omni delivers beautifully pure, fresh tasting water, so there's no need for expensive bottled water. Omni is easy to fit in new or existing kitchens, safe to use and ultra reliable with a 3-year guarantee. Best of all, it's refreshingly affordable.



ONE TAP DOES IT ALL



Dimensions of tank above
Width 182mm, Height 355mm,
Depth 233mm.

4-in-1 technology

Omni is the world's first mechanical 4-in-1 kitchen mixer tap, offering filtered boiling and filtered cold water, as well as the usual mains hot and cold.

Minimal maintenance

Omni is a complete system, including tap, boiler and under sink filter. The filter provides high quality drinking water and also protects the boiler from limescale build-up. Each filter lasts around 6 - 9 months and replacing the filter is as easy as changing a lightbulb.

True 100°C boiling water

Most 'boiling' tap systems only produce less than 98°C so hot drinks don't taste as good as they should. Omni delivers fully boiling 100°C water instantly for the perfect cuppa.

Easy installation

Virtually no tools and minimal plumbing skills are required for installation.

Safety assured

Omni is safer than a traditional kettle in so many ways; there are no cords which can be pulled to avoid any nasty accidents as on a kettle. The childproof push-to-activate lever helps to keep boiling water away from little hands. The lever is also spring loaded to switch off instantly if any splashes occur.

A child safety clip is provided for total protection from curious little hands or visitors to your home. All this and the patented chassis engineering means the tap is never too hot to the touch. It stays cool even when producing boiling water.

A full 3-year guarantee for total reliability

A 3-year manufacturer's guarantee covers the complete system for your total peace of mind.

Exceptional aftercare

Our UK based advisors are always on hand to help. Filters tell you when they need replacing, and replacements are easy to order by phone or online.

www.franke.ie/omni

Omni 4-in-1



- Dispenses 100°C boiling, cold filtered, hot and cold water
- Solid stainless steel
- 4.2L vertical tank
- 3 year working parts guarantee
- 3 year finish and O-ring guarantee

Omni Original 4-in-1

FINISH
Solid Stainless Steel

Omni 4-in-1 Contemporary

FINISH
Solid Stainless Steel



Omni Original in Solid Stainless Steel





Omni Contemporary in Solid Stainless Steel

Minerva 3-in-1 Range

The Minerva 3-in-1 tap provides hot, cold and 100°C boiling water. The humble kitchen tap is transformed into a space-saving, time-saving helper with this boiling water tap and there are 3 stylish designs to choose from.

Safety is assured with a two-step safety handle, while the fully insulated spout and handle ensure that they both stay cool to the touch. The Minerva system features a space-saving water tank that fits discreetly into your kitchen so that boiling water is always ready when you need it.

Discreet and suitable for almost any kitchen, the horizontal heating tank sits neatly behind a standard 150mm cabinet plinth, freeing up much-needed cupboard space. Those who have chosen Minerva in their kitchen have found it not only provides a stylish and functional addition to their home, but is also a real talking point.

Can fit 
VERTICALLY 
or **HORIZONTALLY**
in your cabinet



Dimensions
of tank below
Width 550mm
Height 142mm
Depth 211mm



Please note: The Franke Minerva range of taps require a minimum water pressure of 1.5 bar hot and 1.5 bar cold to function correctly. Please consult your plumber or installer before purchase.

Minerva 3-in-1



- Dispenses 100°C boiling, hot and cold water
- 5L tank can be fitted horizontally or vertically
- Easy to install
- 2 year working parts guarantee
- 2 year finish and O-ring guarantee

Minerva Original 3-in-1

FINISH

Chrome

Minerva Helix 3-in-1

FINISH

Solid Stainless Steel

Minerva Mondial 3-in-1

FINISH

Solid Stainless Steel



Minerva Mondial in Solid Stainless Steel



Minerva Original in Chrome



Minerva Helix in Solid Stainless Steel



*refreshing
water*

that is free
of impurities

Image shows Franke FilterFlow
Olympus Chrome Tap

FilterFlow Taps

The stylish and superbly engineered FilterFlow range is the blueprint for multi-tasking kitchen taps. Having filtered water at your fingertips means no more cumbersome, expensive bottled water, and naturally, there is the peace of mind of knowing your family's drinking water is clean, refreshing and free of impurities. Franke FilterFlow taps remove a wide range of impurities, including chlorine, organic matter, chemical and pharmaceutical traces, metallics and sediment.

What about the things that are good for you?

The FilterFlow tap won't remove minerals and desirable elements such as calcium, magnesium and fluoride. These are dissolved in the water and no part of the filtration process removes these from the water. They remain intact – and help to ensure your water is as healthy as it is refreshing.

Please note: Franke FilterFlow taps require a minimum water pressure of 1 bar (hot and cold). Be sure to ask a qualified installer to check your home's plumbing system and water pressure before purchase.

Franke FilterFlow

Playing our part in reducing plastics free refillable water flasks with selected Franke taps

The amount of plastic going into landfill is an ever-increasing problem. And each year more than 8 million tonnes of plastic finds its way into our oceans - polluting the water, affecting marine life and, in turn, impacting on the food chain and our overall health. One of the biggest contributors to this problem is single use plastic water bottles.

Why not play your part by switching to a sustainable refillable water bottle? We can all help to reduce the impact plastic is having on the planet.

How do FilterFlow taps work?

Franke FilterFlow taps are connected to a compact filter system that is fitted below the sink. When you select the tap's third lever, cold water is diverted through the filter system. The system's filter cartridge removes contaminants before the freshly filtered water travels back through a dedicated waterway inside the tap's spout.

The filtration process

FilterFlow filter cartridges provide a unique and highly effective two-stage filtration process. The cartridges feature an outer ceramic shell and an inner carbon core. The fine ceramic has the ability to trap even the most microscopic of impurities, down to sub-micron level. The activated carbon core is manufactured from solid carbon rod, and eliminates contaminants such as chlorine and heavy metals, as well as unpleasant odours.

Which impurities does a FilterFlow tap remove?

Franke FilterFlow taps will remove a wide range of impurities, including chlorine and chloramine - which you can often smell in tap water - organic matter, chemical and pharmaceutical traces, metallics and sediment. Importantly, a FilterFlow tap also has the capacity to remove harmful, sickness inducing bacteria, if it is present.

Technical essentials

On average, a Franke FilterFlow tap will deliver around 2,500 litres of filtered water before its filter cartridge will need changing. And that couldn't be simpler. It's a 1-2-3 operation and as easy as changing a lightbulb.



Franke FilterFlow Mini



- ABS filter housing
- 5 year working parts guarantee
- 1 year finish and guarantee

FINISH
Chrome

Franke FilterFlow Doric



- Stainless steel filter housing
- 5 year working parts guarantee
- 1 year finish guarantee

FINISH
Chrome
SilkSteel

Franke FilterFlow Olympus



- Stainless steel filter housing
- 5 year working parts guarantee
- 1 year finish guarantee

FINISH
Chrome
SilkSteel

Tasso



- Perlator mixes air into the water to give a champagne-like flow
- 5 year guarantee on working parts and 1 year on coatings, finish and O-rings

FINISH	
	Chrome
	SilkSteel
	Matt Black



Chrome



SilkSteel



Matt Black

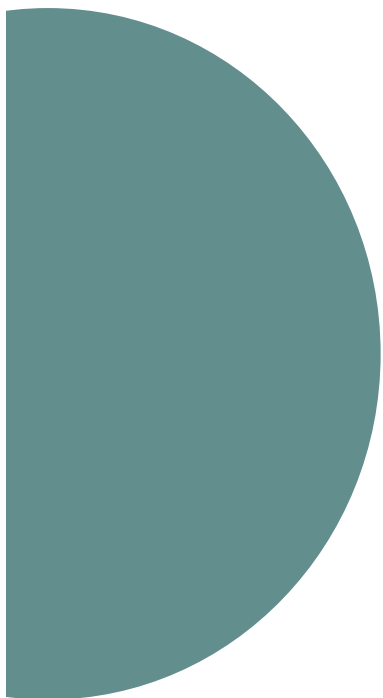



The stakes are high...
and **VERY SOON**

we will have
reached the point of

NO RETURN

It's time to
make a **Vital** change

and
put our **WONDERFUL**
PLANET FIRST.

The Vital Capsule Filter System

The easiest way to enjoy filtered water. It delivers the most wonderful tap water you've ever tasted. Developed in Switzerland, it's the most advanced water filter system in the world.

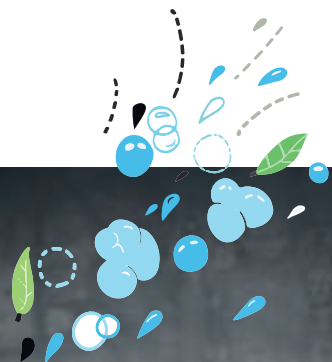

Our water filter is not only the smallest in the world, but also the first to combine activated carbon with a bionic membrane. The flow of water from the filter straight into the glass and the combination of activated carbon and a high-tech membrane ensure supreme water quality. The filter removes bacteria, viruses, pesticides, hormones and microplastics. Not only does tap water taste better, it is also much healthier.

The Franke Vital Capsule taps look stunning in any kitchen. The system is so compact that no complicated installation under the sink is required. An iconic space-saving design is available in various designs and colours. Simply order capsules conveniently online and enjoy fresh water day after day.

Modelled on nature, developed in Switzerland.

All Vital taps are supplied with a High-Performance filter as standard, but for those rare occurrences where an enhanced water flow rate is required, Franke have developed the High-Flow filter which is a superb alternative providing continuous high flow rates in areas where the High-Performance filter can get congested prematurely due to excessive sediment contamination in the water.

The High-Flow filter has a mesh size that is 20 times finer than ordinary household filters. As a result, rust, dirt and fine sediments are filtered out for cleaner water. Please note, the High-Flow filter does not remove microbial cysts, microplastics, bacteria & viruses.

Vital Capsule 3-in-1 Filter Tap Semi-Pro



- 360° rotation
- Pull-out spray
- 5 year working parts guarantee
- 1 year finish guarantee

FINISH	
	Chrome/Gunmetal
	SilkSteel PVD/Matt Black

Vital Capsule 3-in-1 Filter Tap J-Spout



- 360° rotation
- 5 year working parts guarantee
- 1 year finish guarantee

FINISH	
	Chrome/Gunmetal
	SilkSteel PVD/Matt Black

Vital Capsule Single Dispense Filter Tap



- 360° rotation
- 5 year working parts guarantee
- 1 year finish guarantee

FINISH	
	Chrome/Gunmetal
	SilkSteel PVD/Matt Black

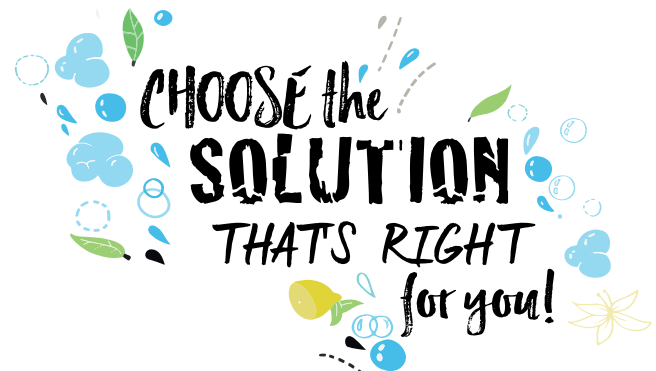

Vital Capsule Filter



FILTER
Single Capsule Filter
Set of three Capsule Filters

NB: Each filter will last approximately 4 months. New filter capsules can simply be reordered online via: central-servicesuk.co.uk



Vital Chiller



- 2.5L Capacity
- Sits in cabinet under the sink
- Temperature range: 5-12°C
- Low noise system
- Stainless Steel
- Compatible only with Vital Capsule filter taps

One size



Franke Tap Range

We place huge importance on creating products that stand the test of time and make your kitchen a more wonderful place to cook and entertain. From extravagant to purist. From SilkSteel finish to polished Chrome or Solid Stainless Steel. Whether you prefer a flexible, pull-out spray or directional nozzle, the Franke tap range meets every need in every kitchen. Your favourite Franke tap will be the perfect complement to your ideal Franke sink. Designed for a discerning clientele, this collection has styles and attributes to meet every taste. Franke is so confident of the quality and manufacture of these models, that we guarantee them between 2 - 5 years on the finish and 5 years on internal working parts.

NEW Atlas Sensor 

**Healthier
HYGIENIC
SAFER**



The Atlas Sensor tap is made of Solid Stainless Steel which has a hygienic, non-porous surface that is resistant to bacteria and germs. Once in use, the water will flow continuously for 30 seconds so no need to worry about flooding if the water is left running unsupervised. The tap can be stopped with a wave, as well as started so, you don't have to wait 30 seconds.

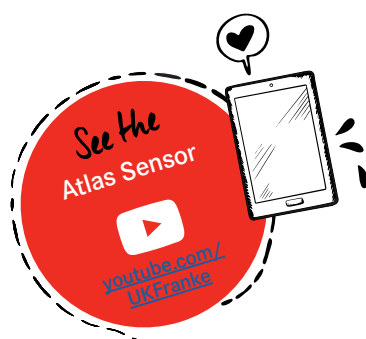

Now YOU CAN WASH YOUR HANDS SAFELY, LOWERING ANY RISKS OF CROSS-CONTAMINATION FOR A SAFER, HEALTHIER, GERM-FREE HOME.



A TOUCHLESS TAP
IS A
Wonderful
THING

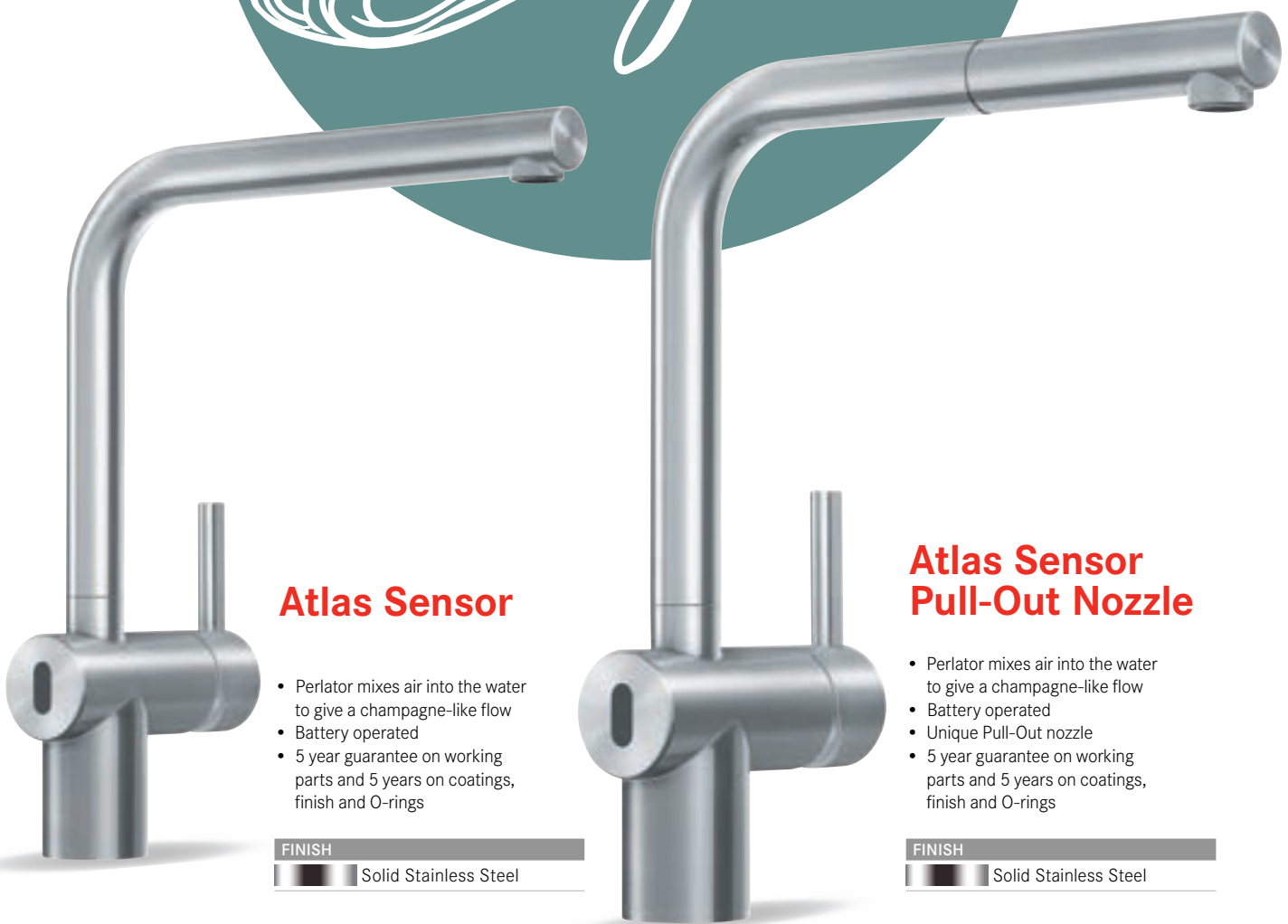

Atlas Sensor

- Perlator mixes air into the water to give a champagne-like flow
- Battery operated
- 5 year guarantee on working parts and 5 years on coatings, finish and O-rings

FINISH
Solid Stainless Steel

Atlas Sensor Pull-Out Nozzle

- Perlator mixes air into the water to give a champagne-like flow
- Battery operated
- Unique Pull-Out nozzle
- 5 year guarantee on working parts and 5 years on coatings, finish and O-rings

FINISH
Solid Stainless Steel





- Hybrid function enabling manual lever for everyday use and sensor activity for hand washing.
- The touchless and manual controls operate independently from each other.
- The sensor screen is easy to keep clean and easy to use.
- The sensor controls the touch free water temperature.
- If unintentionally started and once activated, the water flow stops in less than a second!
- The temperature on the sensor is set upon installation in the control box under the sink.
- Quick and easy plug-in installation: the tap, the control box, and the battery.

INSPIRING
CONTEMPORARY
ORIGINAL
NEW



**Icon Pull Out
Double Jet Shower**



- Unique Pull-Out lever offering single and double jets
- Slim body and high spout make easy work of cleaning, even larger items
- Neoperl Laminar aerator to reduce splashing
- 5 year guarantee on working parts and 1 year on coatings, finish and O-rings

FINISH	
	Chrome
	Décor Steel
	Matt Black



Icon Swivel Spout

- Slim body and high spout make easy work of cleaning, even larger items
- Neoperl Laminar aerator to reduce splashing
- Front-on ergonomic control lever, offering easy operation with busy or dirty hands.
- 5 year guarantee on working parts and 1 year on coatings, finish and O-rings

FINISH	
	Chrome
	Décor Steel
	Matt Black

ICON:
WHERE STYLE &
FUNCTION GET ALONG
FAMOUSLY





TWO SPRAY SETTINGS
BOTH AT A PUSH
OF A BUTTON

FRANKE
PESCARA
SWIVEL UP
AND DOWN



Pull down to
activate spray



Push up for
normal flow



Pescara Swivel Up and Down



- Unique Pull-Down spray
- 5 year guarantee on working parts and 1 year on coatings, finish and O-rings

FINISH
 Chrome

Pescara Pull Down XL



- Pull-Out spray
- 5 year guarantee on working parts and 1 year on coatings, finish and O-rings

FINISH
 Chrome

Pescara 360°



- Pull-Out spray
- 360° rotation
- Quick release magnetic holder
- 5 year guarantee on working parts and 1 year on coatings, finish and O-rings

FINISH
 Chrome

Pescara Semi-Pro XL



Pull-Out Spray



- Quick release magnetic holder
- Perlator mixes air into the water to give a champagne-like flow
- 5 year guarantee on working parts and 1 year on coatings, finish and O-rings

FINISH
 Chrome



Franke Pull-Out Range



With a Pull-Out Nozzle, the spout is connected to a hose you can pull out to where you need your water flow. Ideal for washing salads, as well as filling pots. A Pull-Out Spray also switches between standard flow and spray function for extra versatility. A combination of Side Spray and main tap offers you even more options for your day-to-day kitchen tasks.

Olympus Side Spray



Cold only Side Spray



- Perlator mixes air into the water to give a champagne-like flow
- 5 year guarantee on working parts
- 1 year on finish and O-ring guarantee

FINISH	
	Chrome

Olympus Spring



- Pull out nozzle
- 5 years guarantee on working parts
- 1 year on finish and O-ring guarantee

FINISH	
	Chrome
	SilkSteel

Arena Pull-Out Spray



Pull-Out Spray



- Perlator mixes air into the water to give a champagne-like flow
- 5 year guarantee on working parts
- 1 year on finish and O-ring guarantee

FINISH	
	Chrome
	SilkSteel PVD

Sirino Pull-Out Spray



- 5 year guarantee on working parts
- 1 year on finish and O-ring guarantee

FINISH
Chrome

NEW Eos Neo Pull-Down Spray



- Perlator mixes air into the water to give a champagne-like flow
- Pull-Down spray
- 5 years guarantee on working parts
- 1 year on finish and O-ring guarantee

FINISH
Solid Stainless Steel

Maris Pull-Out Spray



2 Spray Function Trigger

- 5 years guarantee on working parts
- 1 year on finish and O-ring guarantee

FINISH
Chrome
SilkSteel

Fuji Pull-Out Nozzle



Pull-Out Nozzle



- 5 years guarantee on working parts
- 1 year on finish and O-ring guarantee

FINISH
Chrome
SilkSteel

NEW Atlas Neo Pull-Out Nozzle



- Perlator mixes air into the water to give a champagne-like flow
- Pull-Out nozzle
- 5 years guarantee on working parts
- 1 year on finish and O-ring guarantee

FINISH
Solid Stainless Steel

NEW Atlas Neo Soap Dispenser



FINISH
Solid Stainless Steel

Franke Coloured Tap Range



Maris Free Swivel

- Perlator mixes air into the water to give a champagne-like flow
- 5 year guarantee on working parts and 1 year on coatings, finish and O-rings

FINISH	
	SilkSteel PVD
	Matt Black







SilkSteel PVD



Matt Black

Zelus

- Perlator mixes air into the water to give a champagne-like flow
- 5 year guarantee on working parts and 1 year on coatings, finish and O-rings

FINISH	
	Chrome/Spring
	SilkSteel/Spring
	Chrome/Fawn Hose
	Chrome/Black Hose
	Chrome/White Hose



THIS TAP 
Replaced
THE
WAVE



Krios L-Spout

Available in a
**STRIKING
BRUSHED BRASS
FINISH**



- 5 years working parts guarantee
- 1 year on finish and O-ring guarantee

FINISH	
	Chrome
	SilkSteel
	Gunmetal
	Smoked Chrome
	Brass

Krios J-Spout

Available in a
**STRIKING
BRUSHED BRASS
FINISH**



- 5 years working parts guarantee
- 1 year on finish and O-ring guarantee

FINISH	
	Chrome
	SilkSteel
	Gunmetal
	Smoked Chrome
	Brass

Active Plus Pull-Out Spray



- Pull out spray
- Perlator mixes air into the water to give a champagne-like flow
- 5 years working parts guarantee
- 1 year on finish and O-ring guarantee

FINISH	
	Chrome
	Matt Black
	Smoked Chrome
	Brass

Active Plus



- Lever only moves forward
- Perlator mixes air into the water to give a champagne-like flow
- 5 years working parts guarantee
- 1 year on finish and O-ring guarantee

FINISH	
	Chrome
	Matt Black
	Smoked Chrome

Neptune



- Perlator mixes air into the water to give a champagne-like flow
- 5 years working parts guarantee
- 1 year on finish and O-ring guarantee

FINISH	
	Chrome
	Matt Black
	Gunmetal
	Smoked Chrome
	Brass







Active Plus Soap Dispensers

- Fast and easy to operate hand pump for all liquid soaps
- Fits neatly alongside sinks in the worktop



Orlando

- Perlator mixes air into the water to give a champagne-like flow
- 5 year guarantee on working parts and 1 year on coatings, finish and O-rings

FINISH	
	Chrome
	SilkSteel
	Gunmetal
	Smoked Chrome
	Brass



Gunmetal



Brass



SilkSteel



Smoked Chrome



Chrome

Textura

- Perlator mixes air into the water to give a champagne-like flow
- 5 year guarantee on working parts and 1 year on coatings, finish and O-rings



Textura Semi-Pro



- Pull-out nozzle
- Neoperl® aerator for a champagne like flow
- 5 year guarantee on working parts
- 1 year on finish and O-ring guarantee

FINISH
Chrome

Textura U-Spout



- Neoperl® aerator for a champagne like flow
- 5 year guarantee on working parts
- 1 year on finish and O-ring guarantee

FINISH
Chrome

Textura J-Spout



- Neoperl® aerator for a champagne like flow
- 5 year guarantee on working parts
- 1 year finish guarantee

FINISH
Chrome

A HINT OF INDUSTRIAL STYLE

Franke Standard Tap Range

Mythos MTX



- Suitable for low pressure systems
- 5 year guarantee on working parts
- 1 year on finish and O-ring guarantee

FINISH	
	Chrome
	SilkSteel

NEW Gloriana



- Perlator mixes air into the water to give a champagne-like flow
- Suitable for low pressure systems
- 5 year guarantee on working parts
- 1 year on finish and O-ring guarantee

FINISH	
	Chrome
	SilkSteel

NEW Cotswold



- Perlator mixes air into the water to give a champagne-like flow
- Suitable for low pressure systems
- 5 year guarantee on working parts
- 1 year on finish and O-ring guarantee

FINISH	
	Chrome
	SilkSteel

NEW Atlas Neo



- Perlator mixes air into the water to give a champagne-like flow
- 5 years guarantee on working parts
- 5 years finish and O-ring guarantee

FINISH	
	Solid Stainless Steel

NEW Eos Neo



- Perlator mixes air into the water to give a champagne-like flow
- 5 years guarantee on working parts
- 5 years finish and O-ring guarantee

FINISH	
	Solid Stainless Steel



Panto



- Perlator mixes air into the water to give a champagne-like flow
- 5 years guarantee on working parts
- 5 years finish and O-ring guarantee

FINISH
Solid Stainless Steel

Bridge Lever



- Suitable for low pressure systems
- 5 years guarantee on working parts
- 1 year on finish and O-ring guarantee

FINISH
Chrome
SilkSteel

Fuji



- Perlator mixes air into the water to give a champagne-like flow
- 5 years guarantee on working parts
- 1 year on finish and O-ring guarantee

FINISH
Chrome
SilkSteel

Eiger



- Suitable for low pressure systems
- Perlator mixes air into the water to give a champagne-like flow
- 5 year guarantee on working parts
- 1 year on finish and O-ring guarantee

FINISH
Chrome
SilkSteel

Valais



- Perlator mixes air into the water to give a champagne-like flow
- 5 years guarantee on working parts
- 5 years finish and O-ring guarantee

FINISH
Solid Stainless Steel

Bridge



- Suitable for low pressure systems
- 5 years guarantee on working parts
- 1 year on finish and O-ring guarantee

FINISH
Chrome

Cresta



- Perlator mixes air into the water to give a champagne-like flow
- 5 years guarantee on working parts
- 1 year on finish and O-ring guarantee

FINISH	
	Chrome
	SilkSteel



Davos



- Suitable for low pressure systems
- 5 years guarantee on working parts
- 1 year finish and O-ring guarantee

FINISH	
	Chrome
	SilkSteel

Smart



- Perlator mixes air into the water to give a champagne-like flow
- 5 years guarantee on working parts
- 1 year on finish and O-ring guarantee

FINISH	
	Chrome

Anteio



- Suitable for low pressure systems
- Perlator mixes air into the water to give a champagne-like flow
- 5 years guarantee on working parts
- 1 year finish and O-ring guarantee

FINISH	
	Chrome

Davos 'J'



- Suitable for low pressure systems
- 5 years guarantee on working parts
- 1 year finish and O-ring guarantee

FINISH	
	Chrome
	SilkSteel

Hestia U-Spout



- Perlator mixes air into the water to give a champagne-like flow
- 5 years guarantee on working parts
- 1 year finish and O-ring guarantee

FINISH	
	Chrome



Hestia J-Spout



- Perlator mixes air into the water to give a champagne-like flow
- 5 years guarantee on working parts
- 1 year finish and O-ring guarantee

FINISH	
	Chrome
	SilkSteel NEW

Athena



- Perlator mixes air into the water to give a champagne-like flow
- Suitable for low pressure systems
- 5 years guarantee on working parts
- 1 year finish and O-ring guarantee

FINISH	
	Chrome
	SilkSteel

Rotaflow



Directional Nozzle



- Perlator mixes air into the water to give a champagne-like flow
- Suitable for low pressure systems
- 5 years guarantee on working parts
- 1 year finish and O-ring guarantee

FINISH	
	Chrome
	SilkSteel

Zurich



- Suitable for low pressure systems
- 5 years guarantee on working parts
- 1 year finish and O-ring guarantee

FINISH	
	Chrome
	SilkSteel





Kitchen Solutions

Franke innovation doesn't end with sinks and taps.

We strive to make your life easier in every aspect of your kitchen with a range of convenient and practical kitchen solutions. From dealing with unsightly household waste in a hygienic manner to effortlessly sorting waste for recycling, they are designed to save time and to incorporate kitchen essentials discreetly into kitchen units, so that you can maintain a clean, uncluttered kitchen.

Tap Brace



- Connects the tap to the worktop for extra support
- Variable collar fits any model of tap
- Can be used on any stainless steel inset sink

133.0026.896

Waste Bin



- Inset stainless steel system
- 12 litre polyethylene container
- Sits flush with worktop
- Cover keeps odours sealed inside

134.0035.042

Franke Waste Sorter Bins

Fitting neatly into most standard cabinets, Franke Waste Sorters feature separate plastic containers to sort domestic waste into different categories such as food, cans, plastic and paper. A lid closes over the bins to contain any odours. Franke Waste Sorters are the convenient alternative to the conventional waste bin.

Standard door systems

The Franke 300 Series Sorter Systems are a useful addition to any kitchen with standard doors, fitting neatly into 450mm and 600mm kitchen base units. Each bin has a handle that can also be used to secure waste bags. The roll-out carrier is fully waterproof, simple to dismantle and easy to clean.



Sorter 300-45 Duo



- Cabinet width 450mm
- 2 x 22L bin

SORTER
300-45 Duo

Sorter 300-45 Trio



- Cabinet width 450mm
- 1 x 22L bin and 2 x 10L bin

SORTER
300-45 Trio

Sorter 300-60 Duo



- Cabinet width 600mm
- 2 x 22L bin

SORTER
300-60 Duo

Sorter 300-60 Trio



- Cabinet width 600mm
- 1 x 22L bin and 2 x 10L bin

SORTER
300-60 Trio



Franke Waste Disposal Units

A choice of five waste disposal units designed to free the kitchen of unsightly and unhygienic organic household waste. Each unit is the essential add-on for ensuring that all Franke appliances and work surfaces remain looking immaculate. Thanks to a permanent magnet motor, Franke Turbo Elite Waste Disposal Units reach high speed in a split second, producing more torque per kilo than any other of its type. Whilst running water through the unit, food waste is instantly liquefied into fine particles that are easily flushed through the pipework system.

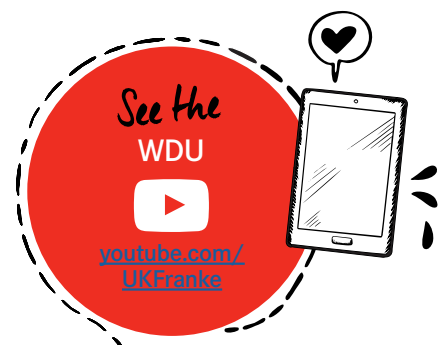



A waste disposal unit can be a wonderful addition to any kitchen. And by following our advice on what you can and cannot put down them, you can keep your disposer in good working order.

Waste disposal units are designed to deal with small amounts of organic waste such as fruit and vegetable peelings, small bones from fish and chicken, coffee grounds, pips and seeds, nutshells, eggshells, rice and leftover meat. But to prevent any problems, avoid putting teabags, seafood shells, corn cobs, banana skins, pineapple leaves or metal, glass, plastic and paper down it. Plus, to keep things smelling clean and fresh, don't use drain cleaner - instead squirt a few drops of lemon juice in there.



Waste Disposal Unit Turbo Elite TE-50



FEATURES	
Feed	Continuous
Motor Horsepower	0.5 HP
Motor Speed RPM	2600
Motor Type	High Torque Dual Magnetic
Air Switch	Integral
Mounting System	Professional 3-bolt
Warranty	10 Years

Waste Disposal Unit Turbo Elite TE-75



FEATURES	
Feed	Continuous
Motor Horsepower	0.75 HP
Motor Speed RPM	2700
Motor Type	High Torque Dual Magnetic
Air Switch	Integral
Mounting System	Professional 3-bolt
Warranty	10 Years

Waste Disposal Unit Turbo Elite TE-125



FEATURES	
Feed	Continuous
Motor Horsepower	1.25 HP
Motor Speed RPM	2800
Motor Type	High Torque Dual Magnetic
Air Switch	Integral
Mounting System	Professional 3-bolt
Warranty	10 Years

Waste Disposal Unit Turbo Elite TE-125B



FEATURES	
Feed	Batch
Motor Horsepower	1.25 HP
Motor Speed RPM	2800
Motor Type	High Torque Dual Magnetic
Air Switch	N/A
Mounting System	Professional 3-bolt
Warranty	10 Years

Waste Disposal Unit Turbo Elite Slimline TE-75S



FEATURES

Feed	Continuous
Motor Horsepower	0.75 HP
Motor Speed RPM	2700
Motor Type	High Torque Dual Magnetic
Air Switch	Integral
Mounting System	Professional 3-bolt
Warranty	10 Years

Extended Flange



An extended flange is available from service agents at extra cost if required when fitting to ceramic sinks.

Please note:
Overflow connector required when fitting WDU in main bowl.



Note:

Chrome Airswitch Button supplied with all Continuous Feed models.

SilkSteel Airswitch Button now available as a spare.





Image shows Urban UBG 651 in Sage Grey with Active Plus Pull-Out Spray in Brass















Technical Specifications

A comprehensive overview of all products in the Franke range incorporating dimensions, formats and available finishes.

Sink Specifications	112-121
Tap Specifications	122-126
Kitchen Solutions	127-128







		Dimensions (mm)				Installation			Plumbing Kit	Finish & Colour Options	FUN Number	
		Cabinet Size	Overall Size	Bowl Size(s)	Cut Out Size cr= Corner Radius	Inset	Undermount	Flushmount				
Stainless Steel Inset Sinks												
Antea AZN 611-86		450	860 x 500	340 x 420 x 160	840 x 480 cr=10	●			S1	Polished	REV 101.0489.523	
Antea AZN 611-100		600	1000 x 500	450 x 420 x 160	980 x 480 cr=10	●			S1	Polished	REV 101.0489.525	
Antea AZN 651		600	1000 x 500	340 x 420 x 155 170 x 280 x 80	980 x 480 cr=10	●			S2	Polished	REV 101.0489.526	
Argos AGX 611-78		450	780 x 510	350 x 435 x 175	766 x 496 cr=10	●			S1	Silk	REV 101.0607.697	
Argos AGX 611-86		450	860 x 510	350 x 435 x 175	846 x 496 cr=10	●			S1	Matt Brushed	REV 101.0531.599	
Argos AGX 611-100		550	1000 x 510	435 x 435 x 180	984 x 494 cr=10	●			S1	Matt Brushed	REV 101.0531.600	
Argos AGX 651		600	1000 x 510	350 x 435 x 175 160 x 300 x 120	984 x 494 cr=10	●			S2	Matt Brushed	REV 101.0531.651	
Box Center BWX 220 54-27		900	860 x 510	540 x 410 x 200 270 x 480 x 200	840 x 490 cr=12	●			S2	Brushed	LHSB 127.0570.616 RHSB 127.0570.617	
Box Center BWX 220 41-27		900	790 x 510	410 x 480 x 204 270 x 480 x 204	770 x 490 cr=10 (inset) 792 x 512 cr=11 (flushmount)	●			S2	Brushed	REV 127.0611.736	
Box Center Compartment Bowl BWX 220 110-27		400	300 x 510	270 x 480 x 204	280 x 490 cr=10 (inset) 302 x 512 cr=11 (flushmount)	●			S1	Brushed	127.0611.738	
Epos EOX 611		500	1000 x 510	445 x 390 x 175	984 x 494 cr=10	●			S1	Silk	LHD 101.0381.857 RHD 101.0381.858	
Epos EOX 651		600	1000 x 510	360 x 390 x 175 160 x 390 x 120	984 x 494 cr=10	●			S2	Silk	LHD 101.0381.860 RHD 101.0381.861	
Galassia GAX 611		600	1000 x 500	450 x 400 x 190	980 x 480 cr=20	●			S1	Silk	LHD 101.0305.130 RHD 101.0305.141	
Galassia GAX 621		900	1160 x 500	450 x 400 x 190 300 x 340 x 170	1140 X 480 cr=20	●			S2	Silk	LHD 101.0381.849 RHD 101.0381.851	
Maris MRX 211		600	1000 x 510	435 x 435 x 180	987 x 497 cr=10	●			S1	Silk	LHD 127.0305.144 RHD 127.0305.145	
Maris MRX 251		600	1000 x 510	350 x 435 x 175 160 x 300 x 120	987 x 497 cr=10	●			S2	Silk	LHD 127.0305.146 RHD 127.0305.147	
Maris MRX 210-19		300	230 x 440	190 x 400 x 130	200 x 410 cr=10	●			S1	Brushed	127.0553.950	

Stainless Steel Inset Sinks		Dimensions (mm)				Installation			Plumbing Kit	Finish & Colour Options	FUN Number
		Cabinet Size	Overall Size	Bowl Size(s)	Cut Out Size cr= Corner Radius	Inset	Undermount	Flushmount			
Maris MRX 210-34		400	380 x 440	340 x 400 x 180	350 x 410 cr=10	●			S1	Brushed	127.0531.915
Maris MRX 210-45		500	490 x 440	450 x 400 x 180	460 x 410 cr=10	●			S1	Brushed	127.0553.961
Maris MRX 210-55		600	590 x 440	550 x 400 x 180	560 x 410 cr=10	●			S1	Brushed	127.0553.962
Maris MRX 260 34-19		600	591 x 436	340 x 400 x 180 190 x 400 x 130	565 x 410 cr=10	●			S2	Brushed	LHSB 127.0553.963 RHSB 127.0570.247
Maris MRX 210-70		800	740 x 440	700 x 400 x 180 cr=10	710 x 410 cr=10	●			S1	Brushed	127.0531.916
Maris MRX 220-34-34		800	745 x 440	340 x 400 x 180 cr=10	715 x 410 cr=10	●			S2	Brushed	127.0531.913
Mythos MYX 210-34		450	352 x 412	340 x 400 x 200	346 x 406 cr=28 (inset) 352.4 x 412.4 cr=31.2 (flushmount)	●	●		S1	Brushed	127.0607.087
Mythos MYX 210-45		550	462 x 412	450 x 400 x 200	456 x 406 cr=28 (inset) 362.4 x 412.4 cr=31.2 (flushmount)	●	●		S1	Brushed	127.0607.088
Mythos MYX 210-55		600	562 x 412	550 x 400 x 200	556 x 406 cr=28 (inset) 562.4 x 412.4 cr=31.2 (flushmount)	●	●		S1	Brushed	127.0607.101
Mythos MYX 210-70		800	712 x 412	700 x 400 x 200	706 x 406 cr=28 (inset) 712.4 x 412.4 cr=31.2 (flushmount)	●	●		S1	Brushed	127.0607.102
Mythos Plus MYX 210 TPL SS		600	580 x 520	500 x 400 x 200	566 x 506 cr=10 (inset) 580.8 x 520.8 cr=10.4 (flushmount)	●			S1	Brushed	127.0640.216
Mythos Plus MYX 210 SS		600	580 x 458	500 x 400 x 200	566 x 444 cr=10 (inset) 580.8 x 458.8 cr=10.4 (flushmount)	●			S1	Brushed	127.0640.218
Mythos Plus MYX 211 TPL SS		600	860 x 520	500 x 400 x 200	846 x 506 cr=10 (inset) 860.8 x 520.8 cr=10.4 (flushmount)	●			S1	Brushed	LH 127.0640.219 RH 127.0640.511
Mythos Plus MYX 211 SS		600	860 x 458	500 x 400 x 200	846 x 444 cr=10 (inset) 860.8 x 458.8 cr=10.4 (flushmount)	●			S1	Brushed	LH 127.0640.512 RH 127.0640.513
Mythos Plus MYX 251 TPL SS		600	860 x 520	Main Bowl: 340 x 400 x 200 Second Bowl: 160 x 400 x 150	846 x 506 cr=10 (inset) 860.8 x 520.8 cr= 10.4 (flushmount)	●			S2	Brushed	LH 127.0640.514 RH 127.0640.515
Neptune NEX 211		600	864 x 514	360 x 420 x 200	855 x 506 cr=20	●			S1	Silk	LHD 127.0059.655 RHD 127.0059.654
Neptune NEX 251		600	1004 x 514	360 x 420 x 200 167 x 306 x 152	995 x 506 cr=20	●			S2	Silk	LHD 127.0059.717 RHD 127.0059.658

		Dimensions (mm)				Installation			Finish & Colour Options	FUN Number	
		Cabinet Size	Overall Size	Bowl Size(s)	Cut Out Size cr= Corner Radius	Inset	Undermount	Flushmount			Plumbing Kit
Stainless Steel Inset Sinks											
Rondo RNX 610		500	Ø339	Ø339 x 150 depth	Ø324	●			S1	Brushed	113.0159.657
Rotondo RBX 610		500	Ø440	Ø395 x 170 depth	Ø425	●			S1	Brushed	101.0033.751
Rotondo RBX 604 DRAINER		500	Ø440	Ø395 x 30 depth	Ø425	●			S1	Polished	101.0050.182
Studio STX 621-E		900 x 900 corner	830 x 830	340 x 400 x 200 300 x 340 x 190	Utilise template	●			S2	Silk	LHD 101.0001.045 RHD 101.0001.044
Spark SKX 611 86		450	860 x 500	340 x 420 x 160	840 x 480 cr=10	●			S1	Silk	REV 101.0489.946
Spark SKX 651		600	1000 x 500	340 x 420 x 155 170 x 280 x 80	980 x 480 cr=10	●			S2	Silk	REV 101.0489.947
Utility 50 UTX 610		600	500 x 450	450 x 400 x 240	460 x 410 cr=50	●			S1	Brushed	113.0159.658



Fragranite Inset Sinks

Antea AZG 611-78		450	780 x 500	360 x 460 x 210	764 x 484 cr=20	●			S1	Polar White	REV 114.0532.312	
										Coffee	REV 114.0532.230	
										Oyster	REV 114.0633.739	
										Stone Grey	REV 114.0633.738	
										Onyx	REV 114.0532.311	
Antea AZG 651		600	970 x 500	430 x 340 x 210 155 x 310 x 115	950 x 480 cr=20	●			S2	Polar White	REV 114.0532.315	
										Coffee	REV 114.0532.313	
										Oyster	REV 114.0633.741	
										Stone Grey	REV 114.0633.740	
										Onyx	REV 114.0532.314	
Antea AZG 621		800	1160 x 500	430 x 340 x 210 430 x 340 x 210	1140 x 480 cr=20	●			S1	Polar White	REV 114.0532.317	
										Coffee	REV 114.0532.316	
										Oyster	REV 114.0633.764	
										Stone Grey	REV 114.0633.742	
										Onyx	REV 114.0532.318	
Basis BFG 611-780		450	780 x 500	340 x 420 x 200	760 x 480 cr=10	●			S1	Polar White	REV 114.0253.155	
										Coffee	REV 114.0253.150	
										Oyster	REV 114.0633.735	
										Stone Grey	REV 114.0501.283	
										Onyx	REV 114.0253.153	
Basis BFG 611-970		600	970 x 500	450 x 420 x 200	950 x 480 cr=10	●			S1	Polar White	REV 114.0284.677	
										Coffee	REV 114.0284.678	
										Oyster	REV 114.0633.736	
										Stone Grey	REV 114.0484.967	
										Onyx	REV 114.0284.679	













		Dimensions (mm)				Installation				Finish & Colour Options	FUN Number
		Cabinet Size	Overall Size	Bowl Size(s)	Cut Out Size cr= Corner Radius	Inset	Undermount	Flushmount	Plumbing Kit		
Basis BFG 651		600	970 x 500	340 x 420 x 200 150 x 290 x 100	950x 480 cr=10	●			S1	Polar White	REV 114.0253.259
										Coffee	REV 114.0253.257
										Oyster	REV 114.0633.737
										Stone Grey	REV 114.0484.968
										Onyx	REV 114.0253.258
Centro CNG 611-78 XL		600	780 x 500	492 x 435 x 200	746 x 466 cr=15	●			S1	Polar White	REV 114.0629.652
										Coffee	REV 114.0629.596
										Oyster	REV 114.0630.233
										Stone Grey	REV 114.0630.234
										Onyx	REV 114.0630.227
										Matt Black	REV 114.0635.762
Maris MRG 611		600	970 x 500	450 x 425 x 200	950 x 480 cr=20	●			S1	Polar White	REV 114.0067.723
										Coffee	REV 114.0067.724
										Oyster	REV 114.0633.791
										Stone Grey	REV 114.0193.698
										Onyx	REV 114.0157.987
										Matt Black	REV 114.0630.355
Maris MRG 651		600	970 x 500	350 x 425 x 200 160 x 302 x 130	950 x 480 cr=20	●			S2	Polar White	REV 114.0067.728
										Coffee	REV 114.0067.731
										Oyster	REV 114.0633.793
										Stone Grey	REV 114.0501.282
										Onyx	REV 114.0157.988
										Matt Black	REV 114.0630.356
Urban UBG 611-86		500	860 x 500	390 x 425 x 220	824 x 464 cr=15 (inset) 864 x 504 cr=17 (flushount)	●		●	S1	Polar White	REV 114.0605.125
										Coffee	REV 114.0605.121
										Oyster	REV 114.0633.765
										Stone Grey	REV 114.0605.126
										Graphite	REV 114.0605.118
										Onyx	REV 114.0605.124
										Matt Black	REV 114.0630.393
										Sage Grey	REV 114.0605.114
										Orion Grey	REV 114.0605.113
Denim Grey	REV 114.0605.112										
Urban UBG 611-100		600	1000 x 500	490 x 425 x 220	964 x 464 cr=15 (inset) 1004 x 504 cr=17 (flushount)	●		●	S1	Polar White	REV 114.0573.803
										Coffee	REV 114.0605.122
										Oyster	REV 114.0633.768
										Stone Grey	REV 114.0573.802
										Graphite	REV 114.0605.119
										Onyx	REV 114.0573.801
										Matt Black	REV 114.0630.399
										Sage Grey	REV 114.0605.111
										Orion Grey	REV 114.0605.040
Denim Grey	REV 114.0605.039										
Urban UBG 651		600	1000 x 500	390 x 425 x 220 166 x 322 x 139	964 x 464 cr=15 (inset) 1004 x 504 cr=17 (flushount)	●		●	S2	Polar White	REV 114.0573.806
										Coffee	REV 114.0605.123
										Oyster	REV 114.0633.771
										Stone Grey	REV 114.0573.805
										Graphite	REV 114.0605.120
										Onyx	REV 114.0573.804
										Matt Black	REV 114.0630.396
										Sage Grey	REV 114.0605.117
										Orion Grey	REV 114.0605.116
Denim Grey	REV 114.0605.115										















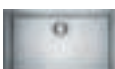

		Dimensions (mm)				Installation			Plumbing Kit	Finish & Colour Options	FUN Number
		Cabinet Size	Overall Size	Bowl Size(s)	Cut Out Size cr= Corner Radius	Inset	Undermount	Belfast			
Ceramic Inset Sinks											
Arcana AHK 611		600	1000 x 500	440 x 405 x 220 Ext. bowl depth: 220	970 X 480 cr=10	●			S1	Gloss White	REV 124.0532.228
Arcana AHK 651		600	1000 x 510	310 x 410 x 200 Ext. bowl depth: 220 160 x 310 x 115 Ext. bowl depth: 137	970 x 480 cr=10	●			S2	Gloss White	REV 124.0532.229
Elba ELK 611		500	920 x 510	395 x 380 x 185 Ext. bowl depth: 210	880 x 460 cr=20	●			S1	Gloss White	REV 124.0307.010
Elba ELK 651		600	990 x 500	345 x 395 x 185 150 x 260 x 100 Ext. bowl depth: 210	970 x 470 cr=20	●			S2	Gloss White	REV 124.0307.011
Galassia GAK 611		800	1010 x 510	460 x 405 x 200	970 x 480 cr=20	●			S1	Gloss White	REV 124.0305.163
Galassia GAK 651		600	1010 x 510	350 x 410 135 x 257	975 x 495 cr=10	●			S2	Gloss White	REV 124.0533.654



Tectonite Inset Sinks

Orion OID 611-94		600	940 x 510	440 x 440 x 190	924 x 494 cr=7.5	●			S1	Polar White	REV 114.0381.756
										Coffee	REV 114.0381.757
										Carbon Black	REV 114.0381.758
Orion OID 651		600	1000 x 510	340 x 440 x 190 160 x 370 x 140	984 x 494 cr=7.5	●			S2	Polar White	REV 114.0381.759
										Coffee	REV 114.0381.760
										Carbon Black	REV 114.0381.791









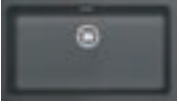

Stainless Steel Undermount Sinks		Dimensions (mm)				Installation			Plumbing Kit	Finish & Colour Options	FUN Number
		Cabinet Size	Overall Size	Bowl Size(s)	Cut Out Size cr= Corner Radius	Inset	Undermount	Belfast			
Ariane ARX 110 17		300	190 x 340	170 x 320 x 130	Utilise template		●		S1	Silk	112.0154.911
Ariane ARX 110 17D		300	190 x 455	170 x 435 x 130	Utilise template		●		S1	Silk	112.0154.958
Ariane ARX 110 33		500	351 x 371	330 x 350 x 160	Utilise template		●		S1	Silk	122.0154.919
Ariane ARX 110 35		500	371 x 456	350 x 435 x 175	Utilise template		●		S1	Silk	122.0154.915
Ariane ARX 160		600	598 x 485	350 x 435 x 175 170 x 320 x 130	Utilise template		●		S1	Silk	LHSB 122.0154.926 RHSB 122.0154.935
Ariane ARX 160D		600	598 x 485	350 x 435 x 175 170 x 435 x 130	Utilise template		●		S2	Silk	LHSB 122.0154.950 RHSB 122.0154.946
Box BXX 110 16		300	200 x 450	160 x 410 x 140	Utilise template		●		S1	Brushed	127.0371.512
Box BXX 110 40		500	440 x 450	400 x 410 x 200	Utilise template		●		S1	Brushed	127.0369.215
Box BXX 110 50		600	540 x 450	500 x 410 x 200	Utilise template		●		S1	Brushed	127.0369.282
Box BXX 110 54		800	580 x 450	540 x 410 x 200	Utilise template		●		S1	Brushed	127.0371.513
Box BXX 110 68		800	725 x 450	685 x 410 x 200	Utilise template		●		S1	Brushed	127.0369.284
Box BXX 160 34-16		600	560 x 450	340 x 410 x 200 160 x 410 x 140	Utilise template		●		S2	Brushed	LHSB 127.0369.916
Box Center BWX 120 41-27		900	820 x 520	410 x 480 x 204 270 x 480 x 204	Download cut out file		●		S2	Brushed	REV 122.0611.737
Box Center Compartment Bowl BWX 220 110-27		400	300 x 510	270 x 480 x 204	Download cut out file	●	●		S1	Brushed	127.0611.738
Largo LAX 110 45		500	470 x 415	445 x 390 x 175	Utilise template		●		S1	Silk	122.0066.736
Largo LAX 110 50		600	524 x 374	500 x 350 x 180	Utilise template		●		S1	Silk	122.0181.453
Largo LAX 110 50-41		600	530 x 440	500 x 410 x 175	Utilise template		●		S1	Silk	122.0250.208

Stainless Steel Undermount Sinks		Dimensions (mm)				Installation			Finish & Colour Options	FUN Number	
		Cabinet Size	Overall Size	Bowl Size(s)	Cut Out Size cr= Corner Radius	Inset	Undermount	Belfast			Plumbing Kit
Largo LAX 120 36-36		900	795 x 440	360 x 390 x 175 360 x 390 x 175	Utilise template		●		S2	Silk	122.0156.181
Largo LAX 160 36-16		600	575 x 420	360 x 390 x 175 160 x 390 x 120	Utilise template		●		S2	Silk	LHSB 122.0156.345 RHSB 122.0156.346
Largo LAX 120 45-30		900	820 x 440	445 x 390 x 175 300 x 340 x 160	Utilise template		●		S2	Silk	RHSB 122.0156.343
Maris MRX 110-19		300	230 x 440	190 x 400 x 130	Utilise template		●		S1	Brushed	122.0553.879
Maris MRX 110-34		450	380 x 440	340 x 400 x 180	Utilise template		●		S1	Brushed	122.0531.850
Maris MRX 110-45		550	490 x 440	450 x 400 x 180	Utilise template		●		S1	Brushed	122.0553.943
Maris MRX 110-55		800	590 x 440	550 x 400 x 180	Utilise template		●		S1	Brushed	122.0553.947
Maris MRX 110-70		800	740 x 440	700 x 400 x 180	Utilise template		●		S1	Brushed	122.0531.911
Maris MRX 160 34-19		800	595 x 440	340 x 400 x 180 190 x 400 x 130	Utilise template		●		S2	Brushed	LHSB 122.0553.949 RHSB 122.0570.242
Maris MRX 120 34-34		800	745 x 440	340 x 400 x 180	Utilise template		●		S2	Brushed	122.0531.853
Mythos MYX 110-16		300	200 x 440	160 x 400 x 200	Download cut out file		●		S1	Brushed	122.0606.889
Mythos MYX 110-34		450	380 x 440	340 x 400 x 200	Download cut out file		●		S1	Brushed	122.0606.948
Mythos MYX 110-45		550	490 x 440	450 x 400 x 200	Download cut out file		●		S1	Brushed	122.0606.949
Mythos MYX 110-55		600	590 x 440	550 x 400 x 200	Download cut out file		●		S1	Brushed	122.0606.969
Mythos MYX 110-70		800	740 x 440	700 x 400 x 200	Download cut out file		●		S1	Brushed	122.0607.061
Mythos MYX 160 34-16		600	555 x 430	340 x 400 x 200 160 x 400 x 150	Download cut out file		●		S2	Brushed	LHSB 122.0607.062 RHSB 122.0607.063
Mythos MYX 160 50-16		800	725 x 440	500 x 400 x 200 160 x 400 x 150	Download cut out file		●		S2	Brushed	LHSB 122.0606.920 RHSB 122.0607.083







	Dimensions (mm)				Installation			Plumbing Kit	Finish & Colour Options	FUN Number
	Cabinet Size	Overall Size	Bowl Size(s)	Cut Out Size <small>cr= Corner Radius</small>	Inset	Undermount	Belfast			
Stainless Steel Undermount Sinks Mythos MYX 120 34-34 	800	745 x 440	340 x 400 x 200 340 x 400 x 200	Download cut out file		●		S2	Brushed	122.0607.085
Rotondo RUX 110 	500	Ø440	Ø395 x 170	Utilise template		●		S1	Silk	127.0050.183

Fragranite Undermount Sinks

Fresno FSG 111 	900	860 x 458	500 x 425 x 195	832 x 430 cr=7.5		●		S1	Polar White REV 135.0633.439 Coffee REV 135.0633.436 Oyster REV 135.0522.726 Stone Grey REV 135.0633.437 Onyx REV 135.0522.725 Matt Black REV 125.0633.431
Kubus KBG 110 34 	400	380 x 440	340 x 400 x 210	Utilise template		●		S1	Polar White 125.0046.871 Coffee 125.0153.575 Oyster 125.0312.757 Stone Grey 125.0435.830 Onyx 125.0153.567
Kubus KBG 110 50 	600	540 x 440	500 x 400 x 210	Utilise template		●		S1	Polar White 125.0046.874 Coffee 125.0153.599 Oyster 125.0312.758 Stone Grey 125.0435.861 Onyx 125.0153.594
Kubus KBG 110 70 	900	802 x 460	742 x 410 x 200	Utilise template		●		S1	Polar White 125.0265.054 Coffee 125.0531.652 Oyster 125.0531.653 Stone Grey 125.0531.654 Onyx 125.0265.053
Kubus KBG 160 	600	558 x 460	340 x 400 x 210	Utilise template		●		S2	Polar White RHSB 125.0046.877 Coffee RHSB 125.0153.630 Oyster RHSB 125.0312.759 Stone Grey RHSB 125.0435.862 Onyx RHSB 125.0153.622
Kubus KNG 110-37 	450	410 x 460	370 x 420 x 200	Utilise template		●		S1	Polar White 125.0633.731 Coffee 125.0633.730 Oyster 125.0633.732 Stone Grey 125.0633.733 Onyx 125.0633.734 Matt Black 125.0630.441

		Dimensions (mm)				Installation			Plumbing Kit	Finish & Colour Options	FUN Number	
		Cabinet Size	Overall Size	Bowl Size(s)	Cut Out Size cr= Corner Radius	Inset	Undermount	Belfast				
Fragranite Undermount Sinks		600	560 x 460	520 x 420 x 200	Utilise template			●	S1	Polar White	125.0633.725	
										Coffee	125.0633.726	
										Oyster	125.0633.727	
										Stone Grey	125.0633.728	
										Onyx	125.0633.729	
										Matt Black	125.0630.442	
Kubus KNG 110-62		800	760 x 460	620 x 420 x 200	Utilise template			●	S1	Polar White	125.0633.721	
										Coffee	125.0633.595	
										Oyster	125.0633.722	
										Stone Grey	125.0633.723	
										Onyx	125.0633.724	
										Matt Black	125.0630.443	
Kubus KNG 120		800	760 x 460	464 x 420 x 200 214 x 420 x 200	Utilise template			●	S2	Polar White	RHSB 125.0633.285	
										Coffee	RHSB 125.0633.284	
										Oyster	RHSB 125.0633.286	
										Stone Grey	RHSB 125.0633.287	
										Onyx	RHSB 125.0633.288	
										Matt Black	RHSB 125.0630.444	

Ceramic Undermount Sinks

Kubus KBK 110 40		500	445 x 445	405 x 385 x 175	Utilise template			●	S1	White	126.0438.430	
										Matt Pearl Grey	126.0532.319	
										Graphite	126.0532.320	
Kubus KBK 110 50		600	545 x 445	505 x 385 x 185	Utilise template			●	S1	White	126.0438.483	
										Matt Pearl Grey	126.0532.321	
										Graphite	126.0532.322	
Kubus KBK 160		600	545 x 445	375 x 385 x 185 115 x 385 x 115	Utilise template			●	S2	White	126.0438.484	
										Matt Pearl Grey	126.0532.324	
										Graphite	126.0532.323	
V&B VBK 160		600	545 x 440	343 x 390 x 173 136 x 272 x 103	Utilise template			●	S2	Gloss White	LHSB 126.0381.814	
V&B VBK 110 21		400	260 x 440	210 x 390 x 180	Utilise template			●	S1	Gloss White	126.0381.816	
V&B VBK 110 33		450	370 x 435	325 x 390 x 175	Utilise template			●	S1	Gloss White	126.0381.820	
V&B VBK 110 50		600	550 x 440	500 x 390 x 200	Utilise template			●	S1	Gloss White	126.0381.823	

















































Ceramic Befast Sinks	Dimensions (mm)				Installation			Finish & Colour Options	FUN Number		
	Cabinet Size	Overall Size	Bowl Size(s)	Cut Out Size <small>cr= Corner Radius</small>	Inset	Undermount	Belfast			Plumbing Kit	
Belfast BAK 710		600	595 x 455	525 x 380 x 215 Ext. bowl depth: 250	N/A			●	S1	Gloss White	REV 130.0305.150
Belfast VBK 710		600	600 x 500	565 x 430 x 180 Ext. bowl depth: 200	N/A			●	S1	Gloss White	130.0381.800
Belfast VBK 720		800	800 x 500	370 x 465 x 200 370 x 465 x 200 Ext. bowl depth: 220	N/A			●	S2	Gloss White	130.0381.811







Image shows Kubus KNG 110-37 Coffee Sink with a Pescara Pull Down Spray tap.





Tap Model	Dimensions (mm)						Features							Valve(s)		Pressure		Finish	FUN Number
	Tap Height	Spout Reach	Base Diameter	Tap Cut-out Diameter	Side Spray Base Diameter	Spray Cut-out Diameter	Perlator	Filtered Water	Instant Boiling Water	Pull-Out Spray	Pull-Out Nozzle	Directional Nozzle	Side-Spray (cold water only)	Ceramic Disc Valve(s)	Compression Valve(s)	Hot Flow Rate at 0.3 bar (litres/min)	Suitable for low pressure		
Active Plus		310	236	50	35		●							●		2.4		Chrome	115.0426.100
																		Brass	115.0524.926
																		Smoked Chrome	115.0524.924
																		Matt Black	115.0524.888
Active Plus Pull-Out Spray		310	236	50	35		●		●					●		1.2		Chrome	115.0426.189
																		Brass	115.0524.927
																		Smoked Chrome	115.0524.925
																		Matt Black	115.0524.890
Antealeo		345	194	44	35		●									4.0	●	Chrome	115.0433.948
Arena Pull-Out Spray		443	196	50	35		●		●					●		2.1		Chrome	115.0158.969
																		SilkSteel PVD	115.0158.970
Atlas Sensor		297	225	45	35		●									1.91		Stainless Steel	115.0638.826
Atlas Sensor Pull-Out Nozzle		297	225	45	35		●			●						1.75		Stainless Steel	115.0638.827
Atlas Neo		297	225	45	35		●									3.67		Stainless Steel	115.0547.856
Atlas Neo Pull-Out Nozzle		297	225	45	35		●			●						2.35		Stainless Steel	115.0638.841
Athena		349	194	46	35									●		5	●	Chrome	115.0311.211
																		SilkSteel	115.0311.215
Bridge		355	192	50 x2	25 x2		●									6.15	●	Chrome	115.0049.960
Bridge Lever		355	192	50 x2	25 x2									●		6.15	●	Chrome	115.0049.962
																		SilkSteel	115.0049.963
Cresta		268	218	48	35									●		2.8	●	Chrome	115.0250.642
																		SilkSteel	115.0250.644
Cotswold		300	238	50	35		●							●		4.02	●	Chrome	115.0636.103
																		SilkSteel	115.0636.104
Davos		257	224	55	35		●							●		4.50	●	Chrome	115.0046.694
																		SilkSteel	115.0046.695
Davos 'J'		398	216	55	35									●		4.50	●	Chrome	115.0050.044
																		SilkSteel	115.0049.940

Tap Model	Image	Dimensions (mm)						Features							Valve(s)		Pressure		Finish	FUN Number
		Tap Height	Spout Reach	Base Diameter	Tap Cut-out Diameter	Side Spray Base Diameter	Spray Cut-out Diameter	Perlator	Filtered Water	Instant Boiling Water	Pull-Out Spray	Pull-Out Nozzle	Directional Nozzle	Side-Spray (cold water only)	Ceramic Disc Valve(s)	Compression Valve(s)	Hot Flow Rate at 0.3 bar (litres/min)	Suitable for low pressure		
Eiger		395	230	48	35		●							●		2.80	●	Chrome	115.0049.989	
																		SilkSteel	115.0049.990	
Eos Neo		387	229	45	35		●							●		3.27		Stainless Steel	115.0638.846	
Eos Neo Pull-Down Spray		433	231	45	35		●		●					●		2.50		Stainless Steel	115.0638.861	
Fuji		390	220	48	35		●		●					●		1.5		Chrome	115.0250.326	
																		SilkSteel	115.0250.327	
Fuji Pull-Out Nozzle		390	230	48	35				●			●				2.80		Chrome	115.0280.225	
																		SilkSteel	115.0280.227	
Gloriana		366	194	58	35		●							●		4.15	●	Chrome	115.0637.111	
																		SilkSteel	115.0637.112	
Hestia J-Spout		358	181	45	35											2.94		Chrome	115.0567.654	
																		SilkSteel	115.0635.794	
Hestia U-Spout		318	197	45	35		●							●		2.94		Chrome	115.0567.655	
Icon Swivel Spout		341	287	50	35		●											Chrome	115.0625.185	
																		Décor Steel	115.0625.186	
																		Matt Black	115.0625.187	
Icon Pull-Out Double Jet Shower		355	237	48	35				●									Chrome	115.0625.188	
																		Décor Steel	115.0625.189	
																		Matt Black	115.0625.190	
Krios J-Spout		391	216	60	35		●										4.84	Chrome	115.0567.598	
																		SilkSteel	115.0567.599	
																		Brass	115.0567.600	
																		Smoked Chrome	115.0567.611	
																		Gunmetal	115.0567.612	
Krios L-Spout		314	212	60	35		●										4.84	Chrome	115.0567.615	
																		SilkSteel	115.0567.617	
																		Brass	115.0567.618	
																		Smoked Chrome	115.0567.620	
																		Gunmetal	115.0567.621	
Maris Free Swivel		425	195	45	35		●										2.4	SilkSteel PVD	115.0543.294	
																		Matt Black	115.0543.285	
Maris Pull-Out Spray		284	207	48	35		●		●					●		1.70		Chrome	115.0363.793	
																		SilkSteel	115.0363.795	
Mythos MTX		365	185	46	35									●		4.38	●	Chrome	115.0049.965	
																		SilkSteel	115.0049.966	





Tap Model	Dimensions (mm)						Features							Valve(s)		Pressure		Finish	FUN Number		
	Tap Height	Spout Reach	Base Diameter	Tap Cut-out Diameter	Side Spray Base Diameter	Spray Cut-out Diameter	Perlator	Filtered Water	Instant Boiling Water	Pull-Out Spray	Pull-Out Nozzle	Directional Nozzle	Side-Spray (cold water only)	Ceramic Disc Valve(s)	Compression Valve(s)	Hot Flow Rate at 0.3 bar (litres/min)	Suitable for low pressure				
Neptune 	343	220	50	35			●							●		3.0		Chrome	115.0533.348		
																		Smoked Chrome	115.0533.347		
																		Brass	115.0533.345		
																		Gunmetal	115.0533.346		
																		Matt Black	115.0533.344		
Olympus Side-Spray 	390	220	60	35	50	30											●	2.10	Chrome	115.0051.538	
Olympus Spring 	540	189	60	35														3.30	Chrome	115.0184.404	
																			SilkSteel	115.0311.190	
Orlando 	324	189	48	35			●									3.20		Chrome	115.0605.458		
																		SilkSteel	115.0605.459		
																		Brass	115.0605.462		
																		Smoked Chrome	115.0605.461		
																		Gunmetal	115.0605.460		
Panto 	403	180	54	35														●	2.6	Stainless Steel	115.0063.559
Pescara Semi-Pro XL 	550	235	46	33			●		●									●	2.8	Chrome	115.0393.974
Pescara 360° 	460	200	37	33			●		●									●	3.2	Chrome	115.0393.976
Pescara Swivel Up & Down 	435	224	50	35					●									●	2.2	Chrome	115.0523.286
Pescara Pull Down XL 	500	233	46	35			●		●									●	2.2	Chrome	115.0523.290
Rotaflow 	335	190	45	35			●		●							4.70	●	Chrome	115.0251.257		
																		SilkSteel	115.0251.258		
Sirino 	478	211	48	35			●		●									●	2.82	Chrome	115.0433.944
Smart 	200	211	48	35			●											●	1.05	Chrome	115.0391.460
Textura J-Spout 	397	215	48	35			●											●	2.86	Chrome	115.0605.465
Textura U-Spout 	337	211	48	35			●											●	2.86	Chrome	115.0605.466









Tap Model	Dimensions (mm)						Features						Valve(s)		Pressure		Finish	FUN Number	
	Tap Height	Spout Reach	Base Diameter	Tap Cut-out Diameter	Side Spray Base Diameter	Spray Cut-out Diameter	Perlator	Filtered Water	Instant Boiling Water	Pull-Out Spray	Pull-Out Nozzle	Directional Nozzle	Side-Spray (cold water only)	Ceramic Disc Valve(s)	Compression Valve(s)	Hot Flow Rate at 0.3 bar (litres/min)			Suitable for low pressure
Textura Semi-Pro 	485	225	48	35			●							●		2.2		Chrome	115.0605.467
Valais 	362	210	55	35			●							●		0.8		Stainless Steel	115.0364.026
Zelus 	455 Spring	230		35												1.7		Chrome/ Spring	115.0567.593
	445 Hose																	SilkSteel/ Spring	115.0567.594
																		Chrome/ Fawn Hose	115.0567.595
																		Chrome/ Black Hose	115.0567.596
Zurich 	275	210	45	35														Chrome	115.0051.172
																		SilkSteel	115.0061.579

Filtered Water Taps

Franke FilterFlow Doric 	404	216	56	35			●									3.90		Chrome	120.0615.357
																		SilkSteel	120.0615.359
Franke FilterFlow Olympus 	383	216	54	35			●									N/A		Chrome	120.0615.443
																		SilkSteel	120.0615.445
Franke FilterFlow Mini 	235	122	32	20			●									N/A		Chrome	120.0615.441
Tasso 	367	240	54	35			●	●								3.70		Chrome	120.0615.447
																		SilkSteel	120.0615.449
																		Matt Black	120.0615.451

Franke Vital Capsule

Vital Single Dispense 	311	120	50	22 or 35			●	●										Chrome/ Gunmetal	120.0551.216
																		Matt Black/ SilkSteel PVD	120.0551.220
Vital 3-in-1 J-Spout Swivel 	477	228	50	35			●	●										Chrome/ Gunmetal	120.0551.218
																		Matt Black/ SilkSteel PVD	120.0551.241
Vital 3-in1 Semi Pro 	550	235	50	35			●	●	●									Chrome/ Gunmetal	120.0551.219
																		Matt Black/ SilkSteel PVD	120.0551.242
Vital Chiller 																		Stainless Steel	120.0578.223

Boiling Water Taps	Dimensions (mm)						Features						Valve(s)	Pressure	Finish	FUN Number		
	Tap Height	Spout Reach	Base Diameter	Tap Cut-out Diameter	Side Spray Base Diameter	Spray Cut-out Diameter	Perlator	Filtered Water	Instant Boiling Water	Pull-Out Spray	Pull-Out Nozzle	Directional Nozzle	Side-Spray (cold water only)	Ceramic Disc Valve(s)			Compression Valve(s)	Min - Max Operating Pressure
Omni 4-in-1 Original		385	215	42	35			●	●					●		1.5-5	Stainless Steel	119.0588.917
Omni 4-in-1 Contemporary		345	255	50	35			●	●					●		1.5-5	Stainless Steel	119.0517.663
Minerva 4-in-1 Electronic		345	255	50	35			●	●					●		2-4	Chrome	119.0518.838
Minerva 4-in-1 Mondial Electronic		330	200	54	35			●	●					●		2-4	Stainless Steel	119.0532.227
																	Champagne Gold	119.0625.371
																	Copper	119.0625.348
																	Industrial Black	119.0625.395
Minerva 4-in-1 Helix Electronic		408	191	54	35			●	●					●		2-4	Stainless Steel	119.0625.396
																	Champagne Gold	119.0625.397
																	Copper	119.0625.398
																	Industrial Black	119.0625.400
Minerva 3-in-1 Original		362.5	189	50	35			●						●		2-4	Chrome	119.0518.861
Minerva 3-in-1 Helix		407	191	54	35			●						●		2-4	Stainless Steel	119.0518.863
Minerva 3-in-1 Mondial		330	200	54	35			●						●		2-4	Stainless Steel	119.0518.864

Sorter Dimensions

Sorter 300-45 Duo

Minimum cabinet size: 450mm	2 x 22L	121.0150.144
-----------------------------	---------	--------------

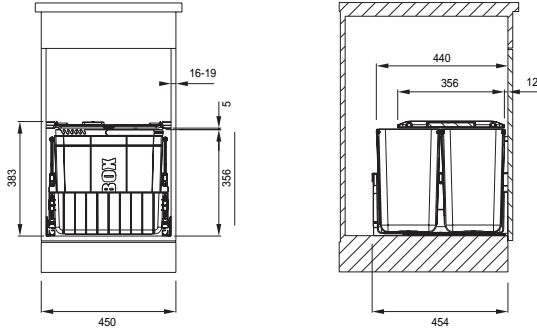

Sorter 300-45 Trio

Minimum cabinet size: 450mm	1 x 22L and 2 x 10L	121.0150.145
-----------------------------	---------------------	--------------

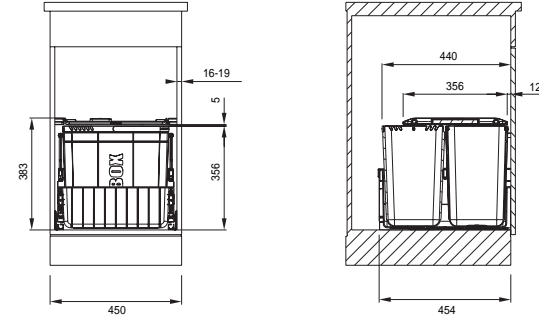

Sorter 300-60 Duo

Minimum cabinet size: 600mm	2 x 22L	121.0150.143
-----------------------------	---------	--------------

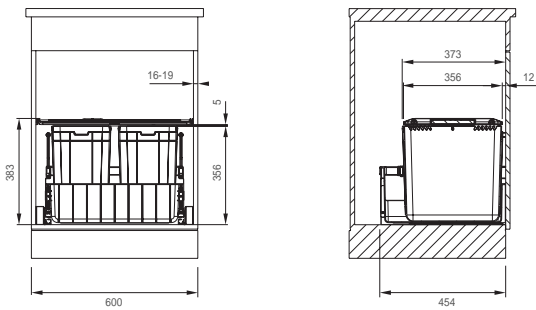

Sorter 300-60 Trio

Minimum cabinet size: 600mm	1 x 22L and 2 x 10L	121.0150.146
-----------------------------	---------------------	--------------

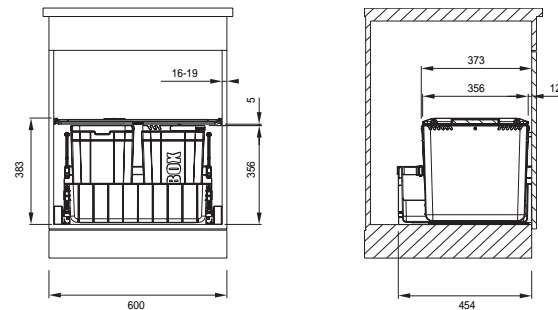





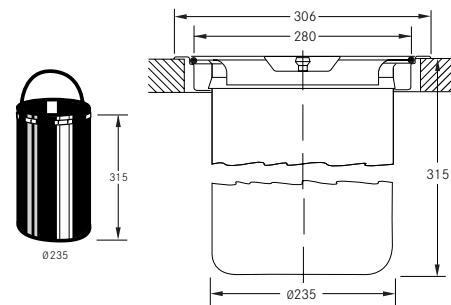

Kitchen Solution Dimensions

Inset Waste Bin

Stainless Steel		134.0035.042
-----------------	---	--------------



Soap Dispenser

Active Plus Chrome		119.0547.902
Active Plus SilkSteel		119.0547.904
Active Plus Brass		119.0547.910
Active Plus Smoked Chrome		119.0547.909
Active Plus Matt Black		119.0547.906
Atlas Neo Solid Stainless Steel		112.0625.483

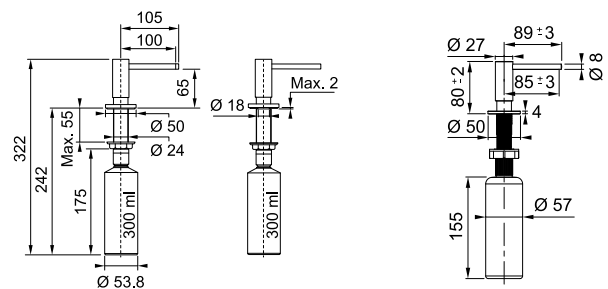

Active Plus Soap Dispenser Dimensions

Atlas Neo Soap Dispenser Dimensions

Andy Chef **Fits Box BXX range.** Features a case, stainless steel strainer bowl, walnut chopping board and chef's knife.

Stainless Steel		112.0619.946
-----------------	---	--------------

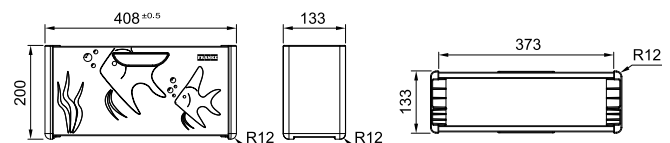

Waste Disposal Unit Dimensions

Waste Disposal Unit Turbo Elite TE-50

Continuous Feed

134.0473.235

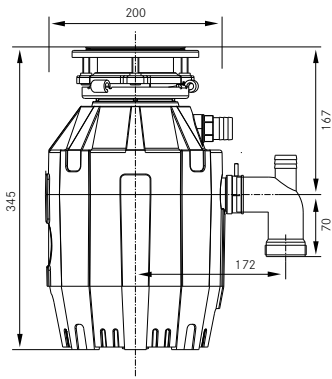

Waste Disposal Unit Turbo Elite Slimline TE-75S

Continuous Feed

134.0483.704

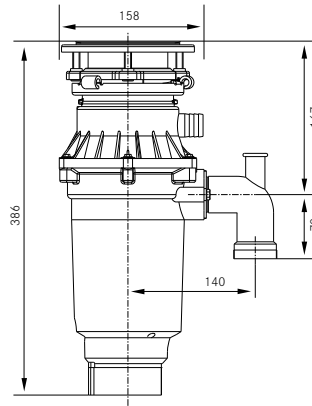

Waste Disposal Unit Turbo Elite TE-75

Continuous Feed

134.0473.236

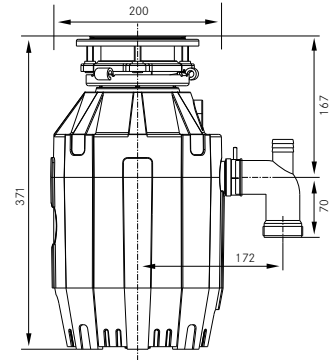

Waste Disposal Unit Turbo Elite TE-125

Continuous Feed

134.0473.237

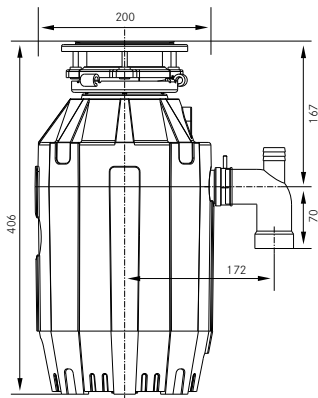

Waste Disposal Unit Turbo Elite TE-125B

Batch Feed

134.0473.238

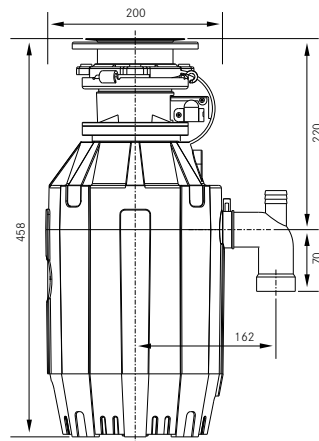

NB. Ensure WDU dimensions can be accommodated within the specified cabinet width.





Image shows KNG 110-52 Polar White Sink with an Atlas Neo tap.



Image shows Mythos MYX 110-45 with a Matt Black Icon Swivel Spout tap.



Colours shown are for reference only. All sinks available with left or right hand drainer. The description 'reversible' means that the design enables the same sink to be turned to drainer on the left or drainer on the right. In the case of a 'handed' sink it is necessary to specify which side the drainer is required, eg MRX 251 left hand drainer or MRX 251 right hand drainer. All bowls sizes and dimensions are described in mm.

Franke sinks are guaranteed against manufacturing defect for 50 years. Franke taps are guaranteed against defective materials and workmanship for 1 year in relation to coatings, 'O' rings and finishes (5 years for stainless steel taps and Frames by Franke taps), and 5 years in relation to valve mechanisms and working parts. Franke will replace (and where appropriate repair) defective sinks. In relation to taps, Franke will, where appropriate, provide replacement parts for your taps or replace your taps at their discretion. Any associated or ancillary costs to be incurred by you as a result of replacement of Franke sinks and taps under this guarantee shall in all cases be previously approved by Franke UK Limited. This guarantee is in addition to and does not affect your statutory rights. For full details see www.franke.ie/guarantee.

This literature has been produced on chlorine free materials harvested from sustainable forests. The Franke policy is one of continual improvement and Franke reserves the right to alter models and specifications without notice. E & OE. Front cover shows Icon Pull Out Double Jet Shower tap in Matt Black.

Make
it
Wonderful

Distributed in Ireland by:
Kitchen Accessories Limited
4078 Kingswood Road
Citywest Business Campus
Dublin 24
Phone +353 (0)1 4136400

01.06.2021

Email kalcsu@kal.ie
www.franke.ie



GOWAN GROUP LIMITED

MAKE IT WONDERFUL

