

# DOOR FRAMES

- The adjustable and fixed rebated door frames can be used for all types of ERKADO internal doors made in both flush and STILE panelled technologies.
- The adjustable non-rebated door frames can be used for internal doors made in both flush and STILE panelled technologies. These door frames are supplied with three concealed hinges.
- The door frame is made with high quality MDF board and covered with durable wood grain film or coated with durable UV paint.
- Depending on the technology, the door frames are faced with: GREKO, CPL, PREMIUM and UV paint.
- The frames for STILE panelled doors have a third hinge as standard.
- Each adjustable and fixed frame comes complete with disassembled frame components, hinges and screws. The components are supplied with pre-drilled holes for fixing.
- Each set is enclosed with assembly manual and warranty certificate.
- The fixed door frame for Herse collection is rectangular and its core is made of glulam.

## ADJUSTABLE DOOR FRAME – REBATED DOORS



## ADJUSTABLE OVERLAY FRAME FOR STEEL DOOR FRAME



## ADJUSTABLE DOOR FRAME – NON-REBATED DOORS



## STAND FIXED DOOR FRAME – REBATED DOORS



## STANDARD SQUARE FOR AN ADJUSTABLE DOOR FRAME

architrave 6 cm / architrave 8 cm

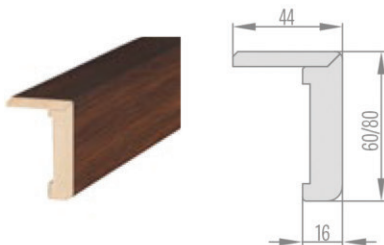

## SQUARE WITH EXTENDED TONGUE FOR ADJUSTABLE DOOR FRAME

architrave 6 cm / architrave 8 cm

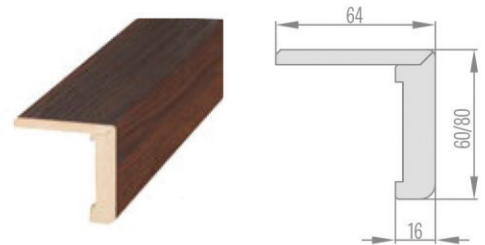

### ADJUSTABLE REBATED DOOR FRAME

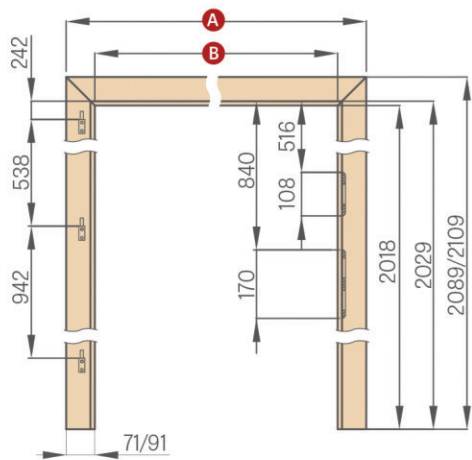

	"60"	"70"	"80"	"90"	"100"	"110"
<b>A</b>	746 / 786	846 / 886	946 / 986	1046 / 1086	1146 / 1186	1246 / 1286
<b>B</b>	604	704	804	904	1004	1104

architrave 6 cm / architrave 8 cm

### ADJUSTABLE NON-REBATED FRAME - PL STANDARD

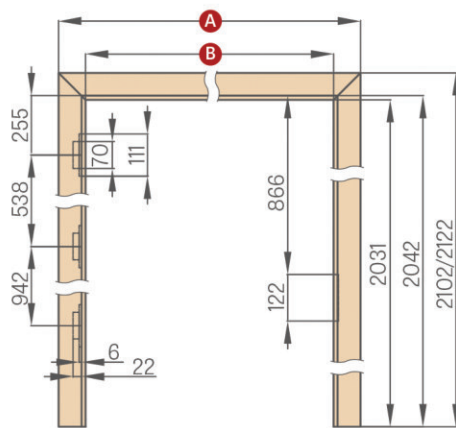

	"60"	"70"	"80N"	"80"	"90"	"100"	"110"
<b>A</b>	771 / 811	871 / 911	947 / 987	971 / 1011	1071 / 1111	1171 / 1211	1271 / 1311
<b>B</b>	629	729	805	829	929	1029	1129

### ADJUSTABLE REBATED DOOR FRAME - PL2112 STANDARD

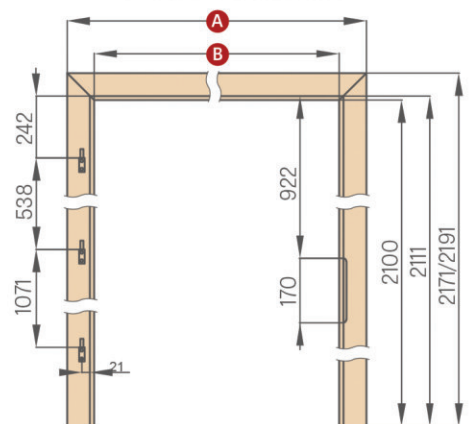

	"60"	"70"	"80"	"90"	"100"	"110"
<b>A</b>	746 / 786	846 / 886	946 / 986	1046 / 1086	1146 / 1186	1246 / 1286
<b>B</b>	604	704	804	904	1004	1104

### ADJUSTABLE NON-REBATED DOOR FRAME - PL2112 STANDARD

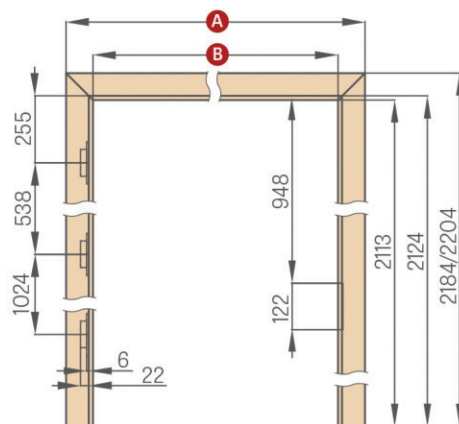

	"60"	"70"	"80N"	"80"	"90"	"100"	"110"
<b>A</b>	771 / 811	871 / 911	947 / 987	971 / 1011	1071 / 1111	1171 / 1211	1271 / 1311
<b>B</b>	629	729	805	829	929	1029	1129

### ADJUSTABLE REBATED DOOR FRAME, TUNNEL TYPE

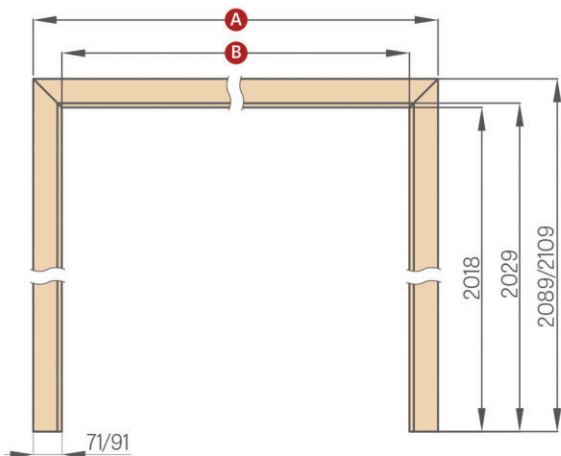

	"60"	"70"	"80"	"90"	"100"	"110"	"120"
<b>A</b>	746 / 786	846 / 886	946 / 986	1046 / 1086	1146 / 1186	1246 / 1286	1346 / 1386
<b>B</b>	604	704	804	904	1004	1104	1204

	"130"	"140"	"150"	"160"	"170"	"180"	"190"
<b>A</b>	1446 / 1486	1546 / 1586	1646 / 1686	1746 / 1786	1846 / 1886	1946 / 1986	2046 / 2086
<b>B</b>	1304	1404	1504	1604	1704	1804	1904

architrave 6 cm / architrave 8 cm

### CASING DOOR FRAME

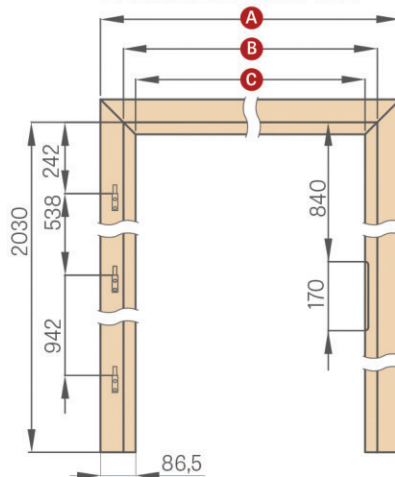

	"60"	"70"	"80"	"90"	"100"
<b>A</b>	737	837	937	1037	1137
<b>B</b>	624	724	824	924	1024
<b>C</b>	564	664	764	864	964

### FIXED DOOR FRAME

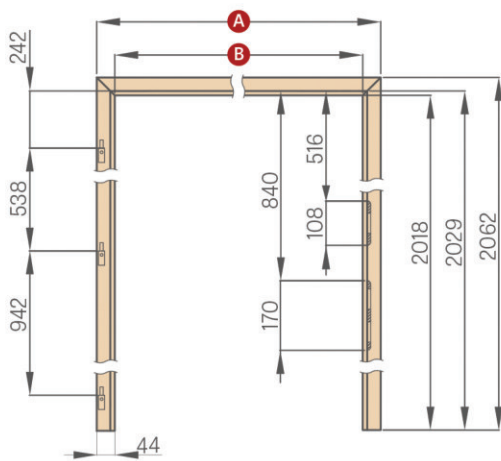

	"60"	"70"	"80"	"90"	"100"	"110"
<b>A</b>	692	792	892	992	1092	1192
<b>B</b>	604	704	804	904	1004	1104

### REVERSE DOOR FRAME

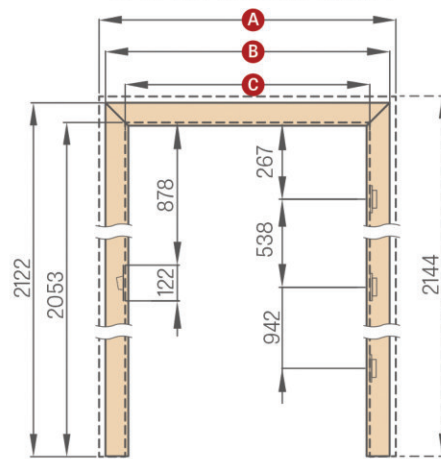

	"60"	"70"	"80N"	"80"	"90"	"100"	"110"
<b>A</b>	834	934	1010	1034	1134	1234	1334
<b>B</b>	791	891	967	991	1091	1191	1291
<b>C</b>	652	752	828	852	952	1052	1152

### FIXED DOOR FRAME FOR DOUBLE DOORS

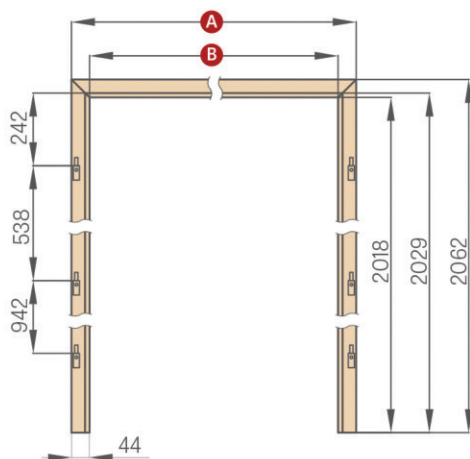

	"90"	"100"	"110"	"120"	"130"	"140"
<b>A</b>	1038	1138	1238	1338	1438	1538
<b>B</b>	950	1050	1150	1250	1350	1450

	"150"	"160"	"170"	"180"	"190"
<b>A</b>	1638	1738	1838	1938	2038
<b>B</b>	1550	1650	1750	1850	1950

### ADJUSTABLE REBATED DOOR FRAME FOR DOUBLE DOORS

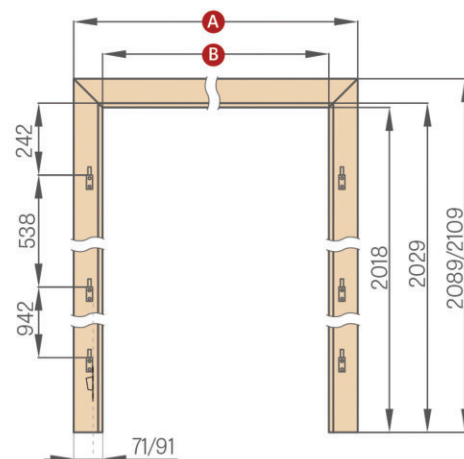

	"90"	"100"	"110"	"120"	"130"	"140"
<b>A</b>	1092/1132	1192/1232	1292/1332	1392/1432	1492/1532	1592/1632
<b>B</b>	950	1050	1150	1250	1350	1450

	"150"	"160"	"170"	"180"	"190"
<b>A</b>	1692/1732	1792/1832	1892/1932	1992/2032	2092/2132
<b>B</b>	1550	1650	1750	1850	1950

architrave 6 cm / architrave 8 cm

### FIXED DOOR FRAME FOR GLASS DOORS

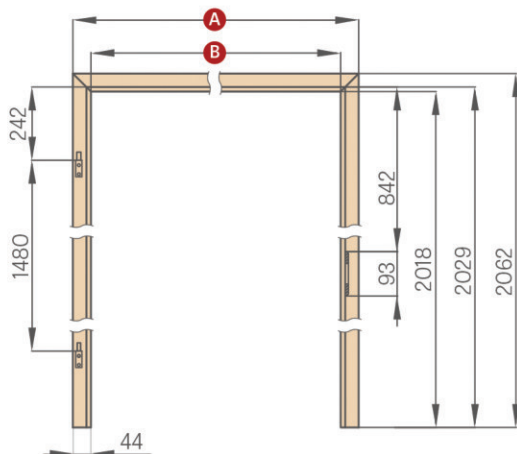

	"60"	"70"	"80"	"90"
<b>A</b>	692	792	892	992
<b>B</b>	604	704	804	904

10 mm pin hinge for glass panes frames

### ADJUSTABLE REBATED DOOR FRAME FOR GLASS DOORS

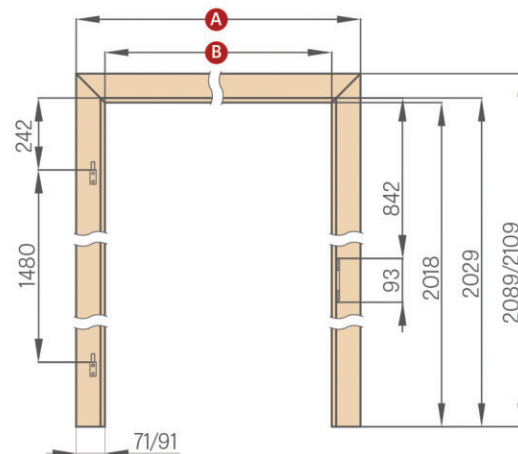

	"60"	"70"	"80"	"90"
<b>A</b>	746/786	846/886	946/986	1046/1086
<b>B</b>	604	704	804	904

architrave 6 cm / architrave 8 cm



# STEEL DOOR FRAME

FOR GRAF STILE PANNELLED, FLUSH & GLASS DOORS

## ADJUSTABLE STEEL DOOR FRAME (OVERLAPPING), sheet metal th. 1.5 mm

Welded and painted in RAL STANDARD and RAL ERKADO

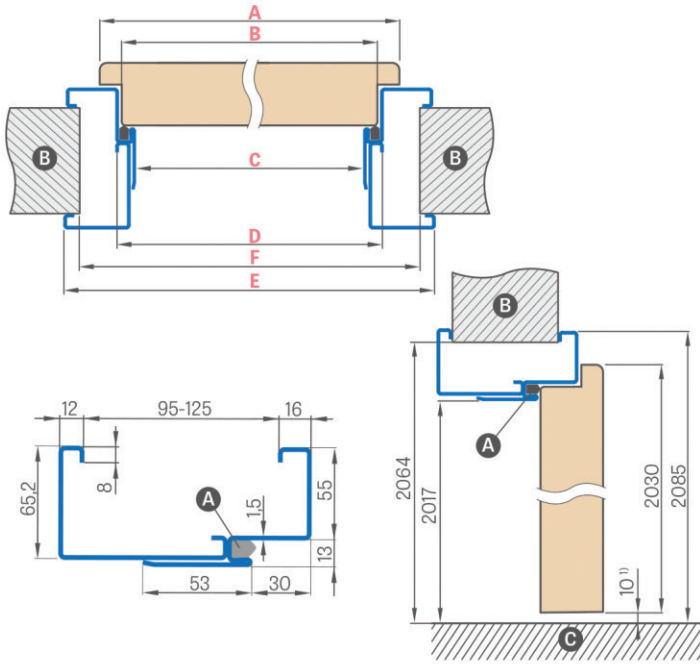

## SQUARE STEEL DOOR FRAME (LARGE), sheet metal th. 1.2 mm

Welded and painted in RAL STANDARD and RAL ERKADO

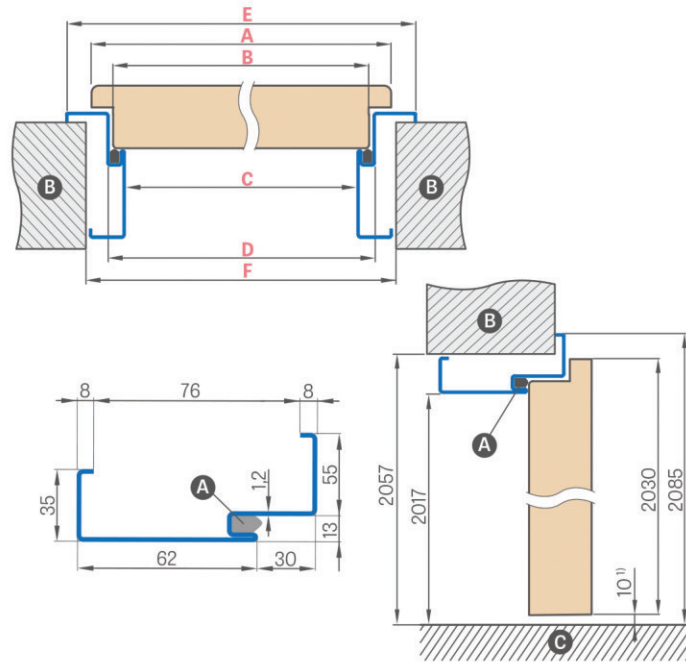

<sup>1)</sup> allowable deviation due to frame dimensional tolerance of  $\pm 3$ mm (we recommend to check before installation)

Door width	A	B	C	D	E	F
"60"	644	617	601	627	737	695
"70"	744	717	701	727	837	795
"80"	844	817	801	827	937	895
"90"	944	917	901	927	1037	995
"100"	1044	1017	1001	1027	1137	1095
"110"	1144	1117	1101	1127	1237	1195

Door width	A	B	C	D	E	F
"60"	644	617	601	627	737	681
"70"	744	717	701	727	837	781
"80"	844	817	801	827	937	881
"90"	944	917	901	927	1037	981
"100"	1044	1017	1001	1027	1137	1081
"110"	1144	1117	1101	1127	1237	1181

### Adjustment Range min-max (mm)

95-125
125-155
155-185
185-215
215-245
245-275
275-305

### RAL STANDARD



### RAL ERKADO



NEW

### FITTING THE SQUARE FRAME



### EXTRA CHARGES

electric door strike

door closer reinforcement

galvanised sheet steel

adjustable frame "100" or "110"

fixed frame "100" or "110"

door frame for double doors

standard 2112

non-typical RAL (intensive, pearly and metallic colours not included)



# STEEL DOOR FRAME

NON-REBATED

FOR PANELLED AND FLUSH DOORS



## ADJUSTABLE STEEL NON-REBATED DOOR FRAME (OVERLAPPING), sheet metal th. 1.5 mm

Welded and painted in RAL STANDARD and RAL ERKADO

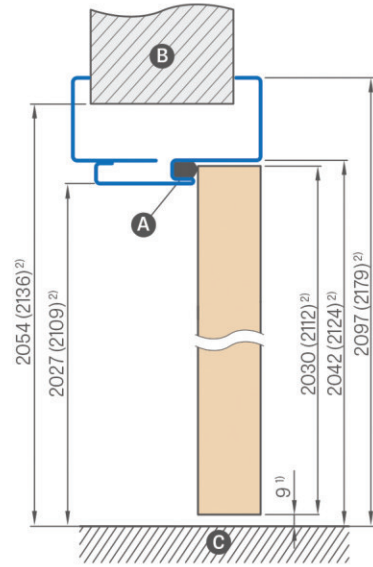
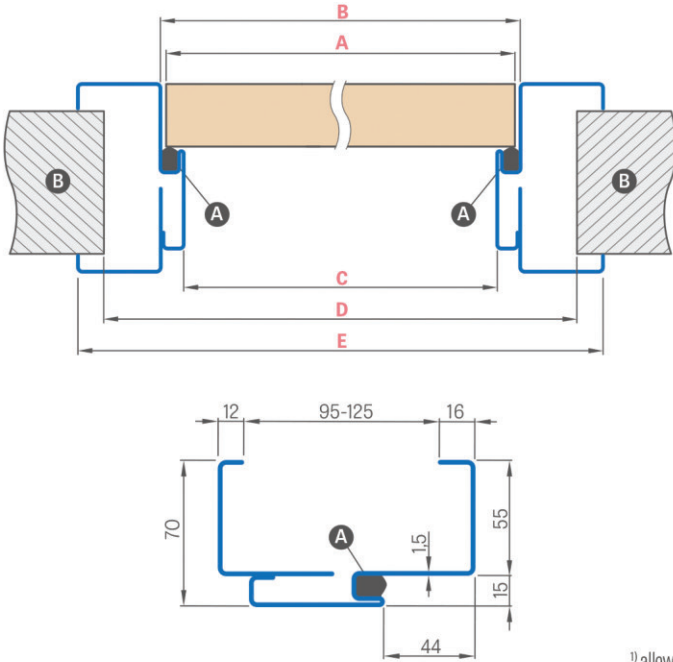

<sup>1)</sup> allowable deviation due to frame dimensional tolerance of  $\pm 3$  mm (we recommend to check before installation)

<sup>2)</sup> 2112 Standard

Adjustment Range min-max (mm)
95-125
125-155
155-185
185-215
215-245
245-275
275-305

Door width	A	B	C	D	E
"60"	644	650	620	695	760
"70"	744	750	720	795	860
"80"	844	850	820	895	960
"90"	944	950	920	995	1060
"100"	1044	1050	1020	1095	1160
"110"	1144	1150	1120	1195	1260

**A** - gasket   **B** - wall   **C** - floor

Door frames come with three hinges as standard.

### EXTRA CHARGES

door closer reinforcement

galvanised sheet steel

adjustable frame "100" or "110"

standard 2112

non-typical RAL (intensive, pearly and metallic colours not included)

RAL STANDARD

RAL 9003	RAL 9010	RAL 9016	RAL 8003	RAL 8017	RAL 7016	RAL 7022	RAL 9005	RAL 7047	RAL 1001

RAL ERKADO

CAPPUCCINO	LIGHT GREY	DARK GREEN	ROYAL BLUE	ASHY	ANTHRACITE	BLACK

NEW



# ADJUSTABLE DOOR FRAME

## NON-REBATED DOOR LEAVES

### ADJUSTABLE DOOR FRAME RANGE 80-95 mm

architrave 6 cm/architrave 8 cm

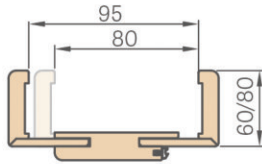

The square tongue is to be trimmed by a customer to required size, for door frames within 80-95mm range

### DOOR FRAME JOINTS

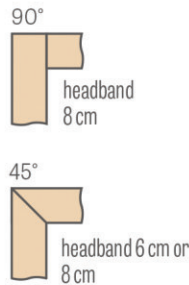

### ADJUSTABLE DOOR FRAME RANGE

architrave 6 cm/architrave 8 cm

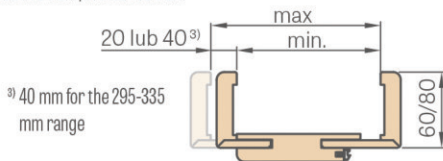

Adjustment Range min-max (mm)
80-95
95-115
115-135
135-155
155-175
175-195
195-215
215-235
235-255
255-275
275-295
295-335
335-355
355-375
375-395
395-415

1 component

2 Components

### ADJUSTABLE DOOR FRAME DIAGRAM

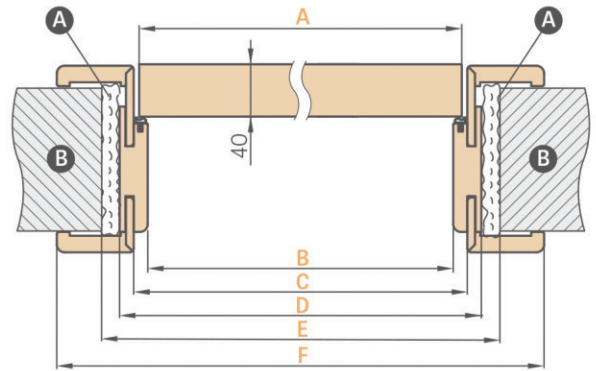

Door width	A	B	C	D	E	F
"60"	644	629	651	673	714	771*/ 811**
"70"	744	729	751	773	814	871*/ 911**
"80N"	820	805	827	849	888	947*/ 987**
"80"	844	829	851	873	914	971*/ 1011**
"90"	944	929	951	973	1014	1071*/ 1111**
"100"	1044	1029	1051	1073	1114	1171*/ 1211**
"110"	1144	1129	1151	1173	1214	1271*/ 1311**

\* architrave 6 cm / \*\* architrave 8 cm

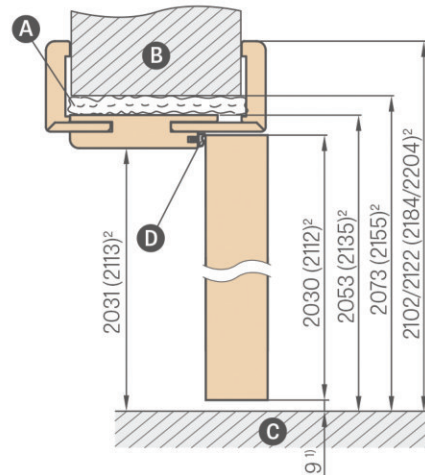

<sup>1)</sup> allowable deviation due to frame dimensional tolerance of +- 3 mm (we recommend to check before installation)

<sup>2)</sup> PL2112 Standard for a surcharge of 15%

**A** foam **B** wall **C** floor **D** rubber gasket

**NOTE:** The working range of frame will be reduced by 3 mm (for single-sided use) or 6 mm (for double-sided use) when a set (crosshead + pilasters) for the non-rebated adjustable frame is selected. Example: assume a 140 mm thick wall with a single-sided kit to be 143mm thick, while with a double-sided kit to be 146 mm thick, and look for a corresponding masonry coverage in the table for rebated frames, non-rebated frames or reverse frames.

- PL2112 standard frame +15% on the frame price before surcharges
- adjustable rebate-free door frame in CPL0.2 is also used in combination with doors in CPL0.7
- option to use black or golden hinges and strike plate – surcharge
- joints at 90 degrees possible for door frames with the 8 cm architraves only. Extra charge for frame joints at 90°
- the door frame above 335 mm is composed of two parts
- prices of adjustable door frames for double doors + 30%
- extension of 120 mm for non-rebated faced frame and CPL 0.2 and painted frame – surcharge
- adjustable square with 2 cm extended tongue and standard square for adjustable frames available in all facings and in CPL0.2 and lacquer – surcharge – for 6cm and 8 cm architraves
- tunnel type door frame for widths of 60, 70, 80N, 80, 90, 100 are at the price of the adjustable rebated door frame
- tunnel type door frame for widths of 110, 120, 130, 140, 150, 160, 170, 180, 190 are at the price of the adjustable door frame for rebated double doors
- top panels glued to the wall (only for frames with 8 cm corner)
- electric door strike (only available for lever tumbler lock) – surcharge





# FIXED DOOR FRAME

## REBATED DOOR LEAVES



### FIXED DOOR FRAME

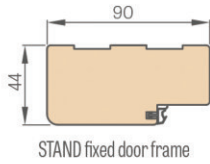

### CLIP-ON SQUARE 6 cm and 8 cm (3 pcs. of clips supplied)

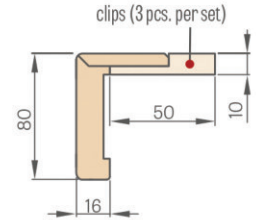

### ARCHITRAVES 8 mm

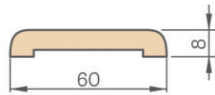

### ARCHITRAVES 16 mm

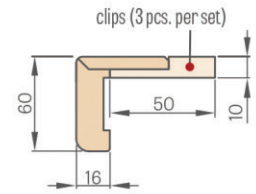
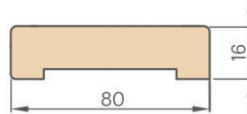

Price for a set of 2 pcs. x 213.5 cm and 1 pc. x 112 cm (for door leaves from "60" to "90")  
 Price for a set of 3 pcs. x 213.5 cm (for door leaves from "100" to "190")

Price for a set of 2 pcs. x 214.5 cm and 1 pc. x 112 cm (for door leaves from "60" to "80")  
 Price for a set of 3 pcs. x 214.5 cm (for door leaves from "90" to "180")

### QUARTER ROUND

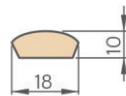

Price for a set of 2 pcs. x 211.5 cm and 1 pc. x 106.5 cm (for door leaves from "60" to "90")  
 Price for a set of 3 pcs. x 211.5 cm (for door leaves from "100" to "190")

### STAND FIXED FRAME

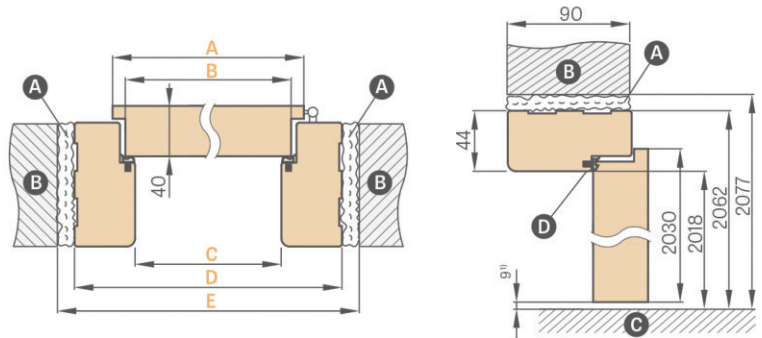

<sup>1)</sup> allowable deviation due to frame dimensional tolerance of  $\pm 3$  mm  
 (we recommend to check before installation)

Door width	A	B	C	D	E
"60"	644	618	604	692	722
"70"	744	718	704	792	822
"80"	844	818	804	892	922
"90"	944	918	904	992	1022
"100"	1044	1018	1004	1092	1122
"110"	1144	1118	1104	1192	1222

**A** foam **B** wall **C** floor **D** rubber gasket

### ELECTRIC DOOR STRIKE

### SKIRTING BOARD length 2.40 lin.m.

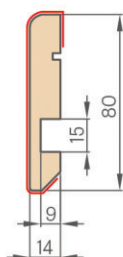

- the skirting board is made of moisture resistant MDF board. Available variants: WHITE TITANIUM UV paint; facings: GREKO, ST CPL, PREMIUM and in a base facing to be paint coated.
- fitting method: bonding to wall

- fixed door frame for double doors + 30%
- non-rebated fixed door frame - NA
- the fixed frame, architrave and clip-on square in CPL 0.2 are also used in the set for door leaves in CPL 0.7
- black strike plate only available for GRAF glass door frames - surcharge



# ADJUSTABLE DOOR FRAME

## REBATED DOOR LEAVES



ADJUSTABLE DOOR FRAME  
above 320 mm

Adjustable door frame with a range above 320 mm consists of two components.

### ADJUSTABLE DOOR FRAME RANGE

architrave 6 cm / architrave 8 cm

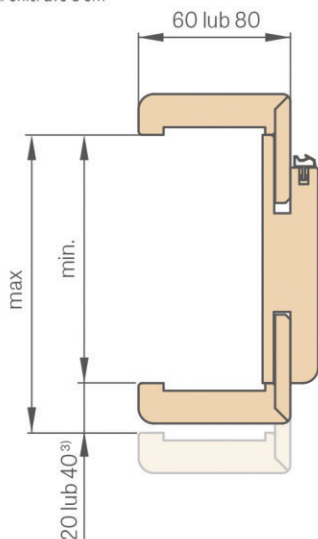

<sup>3)</sup> 40 mm for the 280-320 mm range

### DOOR FRAME JOINTS

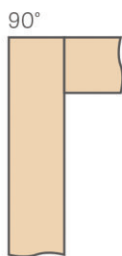

headband 8 cm

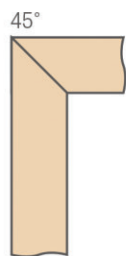

headband  
6 cm or 8 cm

### ADJUSTABLE DOOR FRAME DIAGRAM

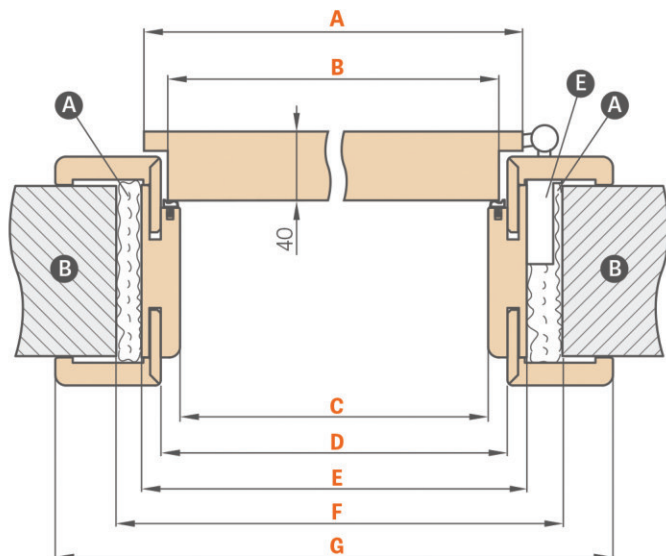

Door width	A	B	C	D	E	F	G
*60"	644	618	604	626	648	688	746*/786**
*70"	744	718	704	726	748	788	846*/886**
*80"	844	818	804	826	848	888	946*/986**
*90"	944	918	904	926	948	988	1046*/1086**
*100"	1044	1018	1004	1026	1048	1088	1146*/1186**
*110"	1144	1118	1104	1126	1148	1188	1246*/1286**

\* architrave 6 cm / \*\* architrave 8 cm

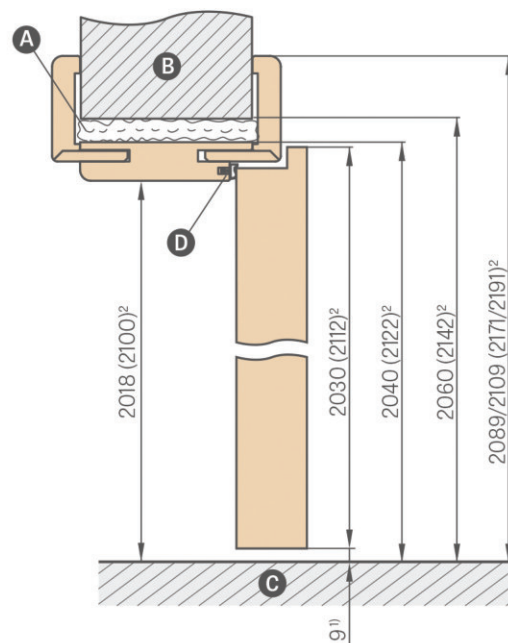

<sup>1)</sup> allowable deviation due to frame dimensional tolerance of  $\pm 3$  mm (we recommend to check before installation)

<sup>2)</sup> PL2112 Standard for a surcharge of 15%

- A** foam **B** wall **C** floor **D** rubber gasket
- E** hinge socket



	Adjustment Range min-max (mm)
1 component	80-100
	100-120
	120-140
	140-160
	160-180
	180-200
	200-220
	220-240
	240-260
	260-280
2 components	280-320
	320-340
	340-360
	360-380
	380-400
	400-420

**NOTE:** The working range of frame will be reduced by 3 mm (for single-sided use) or 6 mm (for double-sided use) when a set (crosshead + pilasters) for the rebated adjustable frame is selected. Example: assume a 140 mm thick wall with a single-sided kit to be 143mm thick, while with a double-sided kit to be 146 mm thick, and look for a corresponding masonry coverage in the table for rebated frames, non-rebated frames or reverse frames.

- PL2112 standard frame + **15%** on the frame price before surcharges
- the CPL 0.2 adjustable rebated frame is also used with CPL 0.7 door leaves
- joints at 90 degrees possible for door frames with the 8 cm architraves only. Additional charge for joining at 90 degrees – surcharge
- electric door strike – surcharge
- reinforcement for door closer – surcharge
- prices of fixed and adjustable door frames for double doors + **30%**
- adjustable square with 2 cm extended tongue and standard square for adjustable frames available in all facings and in CPL 0.2 and lacquer – surcharge – for 6cm and 8 cm architraves
- black strike plate only available for GRAF glass door frames – surcharge
- extension of 120 mm for adjustable faced frame and CPL 0.2 and painted frame – surcharge
- possibility to make door frames ranging between 0 and 520 mm – an additional charge for each 2 cm is PLN 80, relative to the frame price of PLN 400-420 mm
- tunnel type door frame for both rebated and non-rebated door widths of 60, 70, 80N (only non-rebated), 80, 90, 100 are at the price of the rebated adjustable door frames.
- tunnel type door frame for both rebated and non-rebated door widths of 110, 120, 130, 140, 150, 160, 170, 180, 190 are at the price of the adjustable door frame for rebated double doors
- top panels glued to the wall (only for frames with 8 cm corner)